

soundhack ECHO PHON



v2.6

ECHOPHON

FCC -----	3
Limited Warranty -----	4
Installation -----	5
Panel Controls -----	7
Getting Started -----	9
External Feedback Loop -----	10
Patch Ideas -----	11



This device complies with Part 15 of the FCC Rules. Operation is subject to the following two conditions: (1) this device may not cause harmful interference, and (2) this device must accept any interference received, including interference that may cause undesired operation.

Changes / modifications not approved by the Make Noise Co. could void the user's authority to operate the equipment.

This equipment has been tested and found to comply with the limits for a Class A digital device, pursuant to part 15 of the FCC Rules. These limits are designed to provide reasonable protection against harmful interference when the equipment is operated in a commercial environment. This equipment generates, uses, and can radiate radio frequency energy and, if not installed and used in accordance with the instruction manual, may cause harmful interference to radio communications.

Make Noise warrants this product to be free of defects in materials or construction for a period of one year from the date of purchase (proof of purchase/invoice required).

Malfunction resulting from wrong power supply voltages, backwards or reversed eurorack bus board cable connection, abuse of the product, removing knobs, changing face plates, or any other causes determined by Make Noise to be the fault of the user are not covered by this warranty, and normal service rates will apply.

During the warranty period, any defective products will be repaired or replaced, at the option of Make Noise, on a return-to-Make Noise basis with the customer paying the transit cost to Make Noise.

Make Noise implies and accepts no responsibility for harm to person or apparatus caused through operation of this product.

Please contact technical@makenoisemusic.com with any questions, Return To Manufacturer Authorization, or any needs & comments.

<http://www.makenoisemusic.com>



About This Manual:

Written by Tony Rolando

Edited by Walker Farrell

Illustrated by W.Lee Coleman

THANK YOU:

DSP Wizard: Tom Erbe, Soundhack

Beta Analyst: James Cigler

Test Subjects: Surachai, Pete Speer, Aaron Abrams

Spiritual Advisor: Richard Devine

Special Thanx to the Springer Tempophon machine for inspiration

soundhack:<http://www.soundhack.com>

Electrocution Hazard!

Always turn the Eurorack case off and unplug the power cord before plugging or unplugging any Eurorack bus board connection cable.

Do not touch any electrical terminals when attaching any Eurorack bus board cable.

The Make Noise Echophon is an electronic music module requiring 70mA of +12VDC and 40mA of -12VDC regulated voltages and a properly formatted distribution receptacle to operate. It must be properly installed into a Eurorack format modular synthesizer system case.

Go to <http://www.makenoisemusic.com/> for examples of Eurorack Systems and Cases.

To install, 20HP in your Eurorack synthesizer case, confirm proper installation of included Eurorack Bus board connector cable on backside of module (see picture below), plug the bus board connector cable into the Eurorack style bus board, minding the polarity so that the RED stripe on the cable is oriented to the NEGATIVE 12 Volt line on both the module and the bus board. On the Make Noise 6U or 3U Busboard, the negative 12 Volt line is indicated by the white stripe.

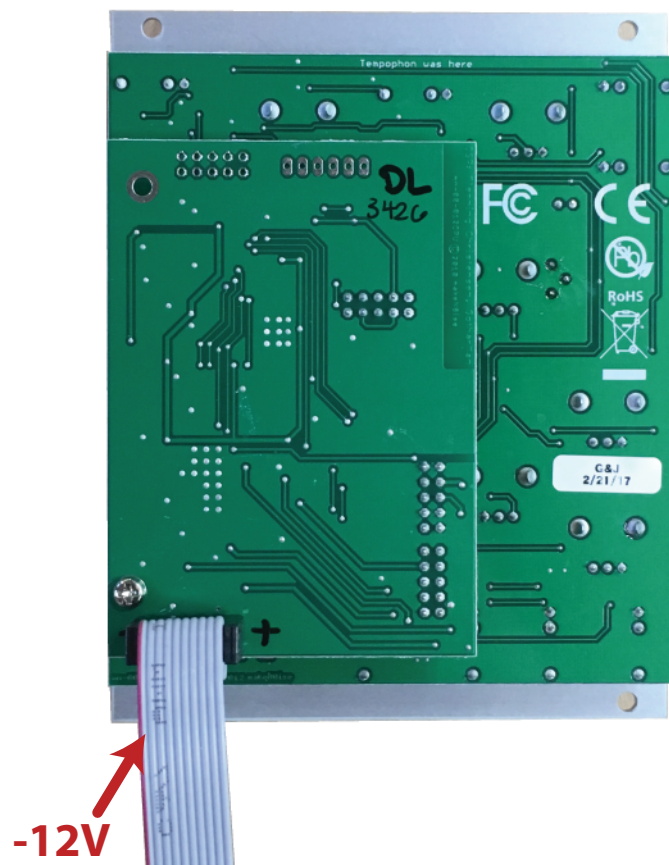

Please refer to your case manufacturers' specifications for location of the negative supply.

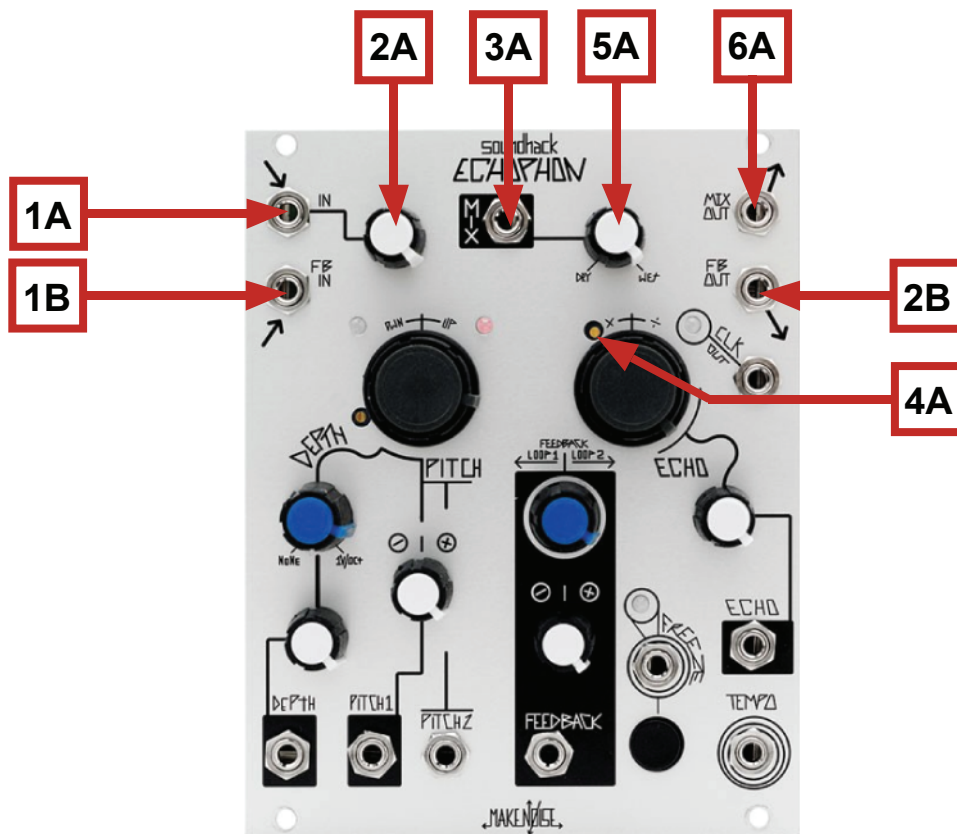

Echophon Panel Controls

Audio Input/ Output

- 1A. Signal Input: AC coupled, expects standard signal level of 10Vpp signal.
- 2A. Level Control for Signal Input: overloads at 3:00 to 5:00.
- 3A. Mix CV Input: unipolar control input. Range 0V to +5V.
- 4A. (Removed)
- 5A. Mix Combo Pot: blends between Dry (un-processed) signal & Wet (processed) Signal. With nothing patched to Mix CV Input, works as standard panel control. With Signal Patched to Mix CV Input, works as attenuator for that signal.
- 6A. Mix Output: 10Vpp (depending upon Level setting and source material), AC coupled.

External Feedback

- 1B. Feedback Input: AC coupled return for external FB loop. Expects standard signal level of 10Vpp.
- 2B. Feedback Output: AC coupled, 10Vpp send for external FB loop.

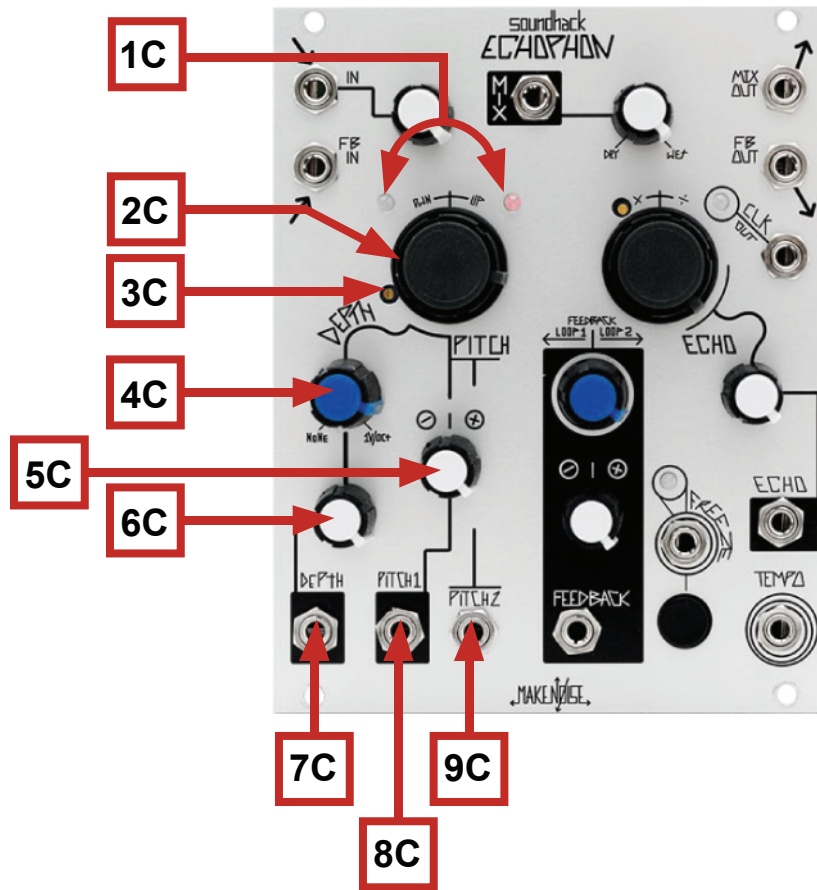

Echophon Panel Controls (cont'd)

Pitch Shift

- 1C. Temphonic LEDs: indicate mechanics of the pitch-shifting machine.
- 2C. Pitch Panel Control: bipolar panel control. At 12:00 no pitch shift, greater than 12:00 shifts pitch Up and less than 12:00 shifts pitch Down. Range is always dependent upon Depth setting.
- 3C. Pitch Trim (Calibration Use Only)
- 4C. Depth Panel Control: unipolar panel control that sets the index of the pitch shift, ranging from sub-microtonal chorusing to 4 octaves harmonizing.
- 5C. Pitch 1 CV Attenuverter: bipolar attenuator for Pitch 1 CV Input.
- 6C. Depth CV Attenuator: unipolar attenuator for Depth CV Input.
- 7C. Depth CV Input: unipolar control signal input. Range 0V to +5V.
- 8C. Pitch 1 CV Input: bipolar control signal input. Range +/- 4V.
- 9C. Pitch 2 CV Input: bi-polar control signal input. Range +/- 2V for total of 4 octave range. Set Pitch Panel Control to full CCW for uni-polar control such as analog sequencer, or to 12:00 for bi-polar control signal such as CV Keyboard.

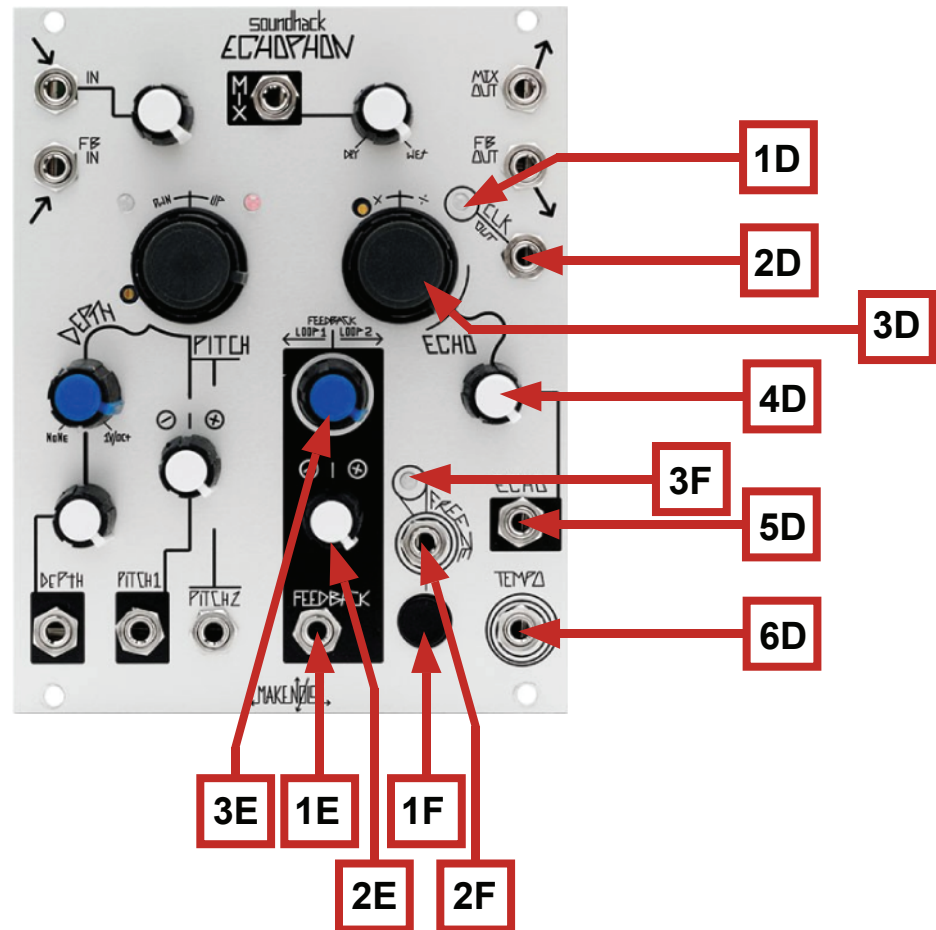

Echophon Panel Controls (cont'd)

Echo

- 1D Echo Time LED: Indicates Tempo of the Echo Clock.
- 2D Echo Clock Output: outputs the Echo Time as 4ms wide clock pulse. 0V-5Vpp
- 3D Echo Time Panel Control: sets time/ length of Echo, from 7ms to 1.7 sec
- 4D Echo Time CV Attenuator: unipolar attenuator for Echo Time CV Input.
- 5D Echo Time CV Input: unipolar control signal input. Range 0V to +8V.
- 6D Tempo Input: allows synchronization of Echoes to multiple or division of an external Clock. While following external Tempo the Echo Time Controls will Multiply or Divide the incoming clock. Requires Clock/Gate signal amplitude of at least 1.5V and width of at least 6ms.

Internal Feedback Loops

- 1E Feedback CV Input: bipolar control signal input. +/- 8V.
- 2E Feedback CV Input Attenuverter: bi-polar attenuator for Feedback CV Input.
- 3E Feedback Panel Control: bipolar panel control that determines the amount and direction of feedback. At 12:00, there is no feedback. Turning CCW from 12:00 to 7:00 sends increasing amounts of feedback to the loop around the Pitch Shifter. Turning from 12:00 to 5:00 sends increasing amounts of feedback to the loop around the Echo.

Freeze

- 1F Freeze Button: toggles Freeze on/ off. When Freeze is On, all sound in the Echo chamber is held until Freeze is turned Off
- 2F Freeze Gate Input: Freezes on Gate High. 1.5V trigger signal to operate.
- 3F Freeze LED: indicates status of the Echo chamber. Lights when Freeze is activated.

Patch the signal to be processed into the Signal Input (1A). The associated Level Control (2A) accommodates modular synthesizer signals of 10Vpp for the first 70% of its rotation. Beyond 2:00 on the Level Control, there is clipping followed by digital overloading. Take your output from the Mix Output (6A) and patch to your signal mixer/monitoring system. Set the Mix Panel Control (5A) to about 12:00 for the typical patch.

The Depth control (4C) acts to set the range of the Pitch Shifting. It could be thought of as a Digital VCA for the control voltages patched to Pitch 1 (8C) and Pitch 2 (9C) as well as the Pitch Panel Control (2C). With Depth at 7:00, there is no Pitch Shifting. Up to around 12:00 the Pitch Shifting is subtle, introducing chorusing effects. Increasing the Depth beyond 12:00 creates increasingly deeper pitch shifting until finally at full counterclockwise the full 4 octave range of harmonizing is possible. The Depth parameter is best modulated with linear functions such as an envelope generated by the MATHS.

The PITCH controls alter the perceived pitch of the sound. Pitch 1 (8C) has an associated attenuverter (5C) allowing you to add or subtract the control signal patched from the setting of the Pitch Panel Control (2C) and Pitch 2 (9C). Pitch 1 is perfect for patching an LFO for Vibrato effects. By adjusting the associated attenuator (5C) the depth of the Vibrato is programmable. Pitch 2 (9C) is well suited for patching a sequencer CV or Keyboard CV. Since most analog sequencers generate uni-polar CV in the range of 0V to 5V, you will need to set the Pitch Panel Control (2C) to Full CCW in order to control the entire range of Pitch.

The Echo Time panel control (3D) sets the length of the Delay line, ranging from 7ms at Full CCW to 1.7sec at Full CW. Patch into Echo CV Input (5D) and adjust the associated uni-polar attenuator (4D) to modulate Echo Time. Just about any source will work wonderfully as this parameter has a smooth exponential response tailored for great modulations.

If you patch an external Clock signal to the Tempo Input (6D), the ECHOPHON will follow that Clock, and the Echo Time controls act to set a Divisor or Multiplier of that Master Tempo. The slowest clock (input or output) is limited to the delay time, so to get a clock division of $\div 12$ out, you need a fairly fast clock in (1.7s/12 or .15s).

The Feedback Panel Control (3E) is bi-polar with 0 to <12:00 sending Feedback through Loop1, 12:00 sending no feedback and 12:00 to 5:00 sending Feedback to Loop 2. Loop 1 goes around the Pitch Shifter and so each regeneration pitch shifts again, resulting in spiraling echoes that rise out of audibility or fall into sub sonic obscurity. Loop 2 creates traditional Echo Repeats. Bi-polar modulation of Feedback is a unique element of the Echophon allowing the two feedback loops to be continuously cross-faded. When Feedback goes to Zero (at 12:00, 0V), the delay line empties out after one echo, so the ratio between Echo Time and the rate of the signal modulating Feedback will be an important factor in bi-polar modulation. A pronounced bi-polar modulation of Feedback is achieved with a mid-range LFO (around 4hz). Audio Rate bi-polar modulation is subtle and gorgeously resonant. Signals such as an ASR envelope with a long Fall Time or a sequenced program change from PRESSURE POINTS are useful for animating a sound within a composition. For example, a cluster of notes is emphasized by increasing feedback resulting multiple repeats.

Using FREEZE:

Once your signal is passing through the ECHOPHON, pushing the Freeze button (1F) or sending a Gate High to the Freeze Gate Input (2F), will cause the ECHOPHON close the Echo chamber and hold the sound inside. The Freeze LED (3F) lights to indicate this state. While the ECHOPHON is Frozen the Pitch may be controlled using the Pitch parameters. The Echo Time parameters changes the sound destructively. Feedback controls do nothing while the ECHOPHON is Frozen. Note is that the Freeze Button is Top Priority, meaning that the Freeze Gate Input has no effect when Freeze has already been toggled On using the Freeze Button.

Patch the Feedback Output (2B) to an external module such as the modDemix. Set up the external module to process the Feedback Output signal. For the modDemix, you could set up the typical Ring Modulation patch where you have a Sine or Triangle waveform from a VCO patched to the Carrier input on the modDemix. The Feedback Output signal is patched to the Signal Input on the modDemix. Take modDemix Signal Output and patch to the final stage in the external Feedback loop, the VCA. The OPTOMIX works nicely as the final VCA stage in an external feedback loop patch. Patch the Signal Output from the modDemix to the Signal Input on the OPTOMIX. Take the Signal Output from the OPTOMIX to the Feedback Input (1B) on the ECHOPHON. Set the OPTOMIX Control Level to determine the amount of regenerations.

Other modules could be placed in the loop to create more complex sounds, but it is important to have a VCA (or manual attenuator) at the end of the loop for gain control. Without this final gain control stage, the external feedback loop might be hard to tame and utilize in a musical way.

CLOCK Division/ Multiple: While a Master Clock is patched to the Tempo Input, the Echo Time control acts to multiply or divide the Master Clock. Below is a list of the possible ratios:

Echo Time <12:00 1/16, 3/32, 1/8, 3/16, 1/4, 3/8, 1/2, 3/4,
Echo Time 12:00 = 1/1
Echo Time >12:00 = 3/2, 2/1, 3/1, 4/1, 6/1, 8/1, 12/1

The slowest clock (input or output) is limited to the delay time, so to get a 12/1 out, you need a fairly fast clock in (1.7s/12 or .15s).

TIP & TRICKS:

-The Signal Input is optimized for 10Vpp signals; however, it is possible to create much more powerful signals within the euro system, so use the Level Control to achieve clean sounds.

-Patch a VCA or attenuator in front of the Feedback Input.

-Use Feedback Input for a secret sound that will occur only as an echo repeat.

-Use Feedback Output to skip the pitch shifting machine.

-Modulate Depth to create Harmonic sequences.

-To achieve pitch-shifting, Depth must be set to greater than 9:00.

-Subtle Pitch Shifts (low Depth setting)

-To sequence full range of Pitch, set Pitch Panel Control to Full CCW and patch sequencer CV to Pitch 2.

-When the delay time is below 20 milliseconds, the delay is acting like a comb filter. Feedback affects the harmonics being emphasized.

All patches require signal to be processed patched to Signal Input with Level Control set to accommodate incoming signal and Mix Output patched to signal mixer/monitoring system.

The Pillars of Hercules: this patch is designed for processing percussive sounds. Mix 12:00, Depth 2:00, Pitch 7:00, Feedback 7:00 (for Loop 1), Echo Time 7:00.

Mult Envelope used for controlling Amplitude of the percussive sound to ECHOPHON Depth CV Input and set associated attenuator to 12:00.

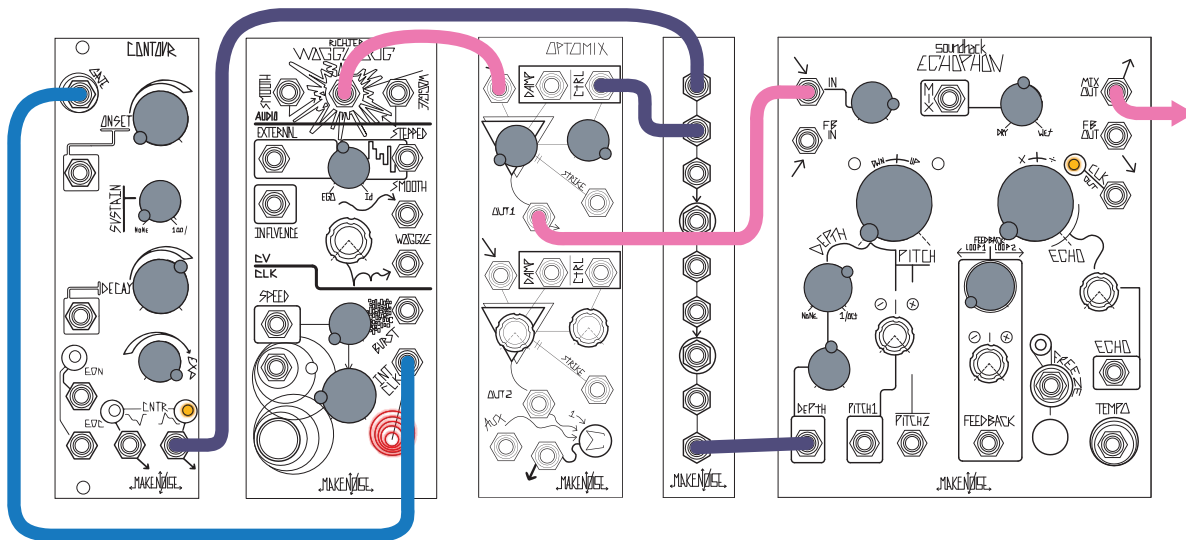

Sliding Universal Phonogene: create loops, transpose, maintain original tempo. Depth to 0% (no pitch shift), Mix 5:00, Feedback 12:00 (no feedback)

Patch external Master Clock to Tempo Input. Set Echo Time to 12:00 or more for division of Master Clock. Utilize Freeze Button to grab a loop. Now, set Depth to full clockwise and use Pitch to play Freezed sound melodically without changing tempo.

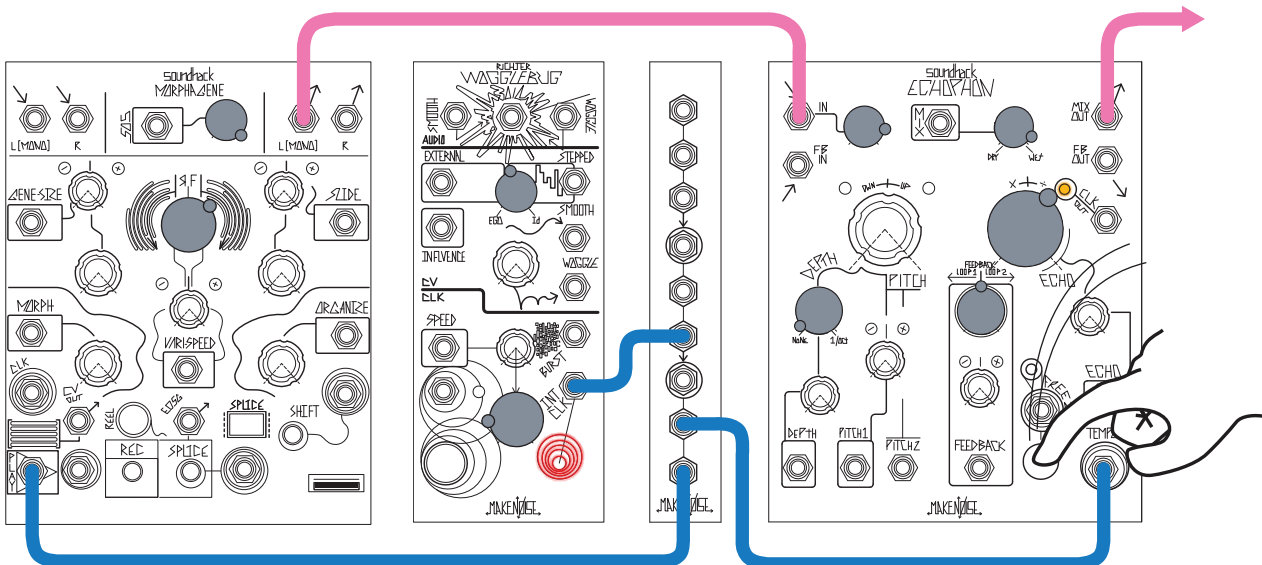

Digicello:

Patch Pink Noise to Signal Input of OPTOMIX Channel 1. Signal Output from OPTOMIX Channel 1 to Signal Input ECHOPHON. Make the following settings: Level 3:00, Mix 5:00, Depth full clockwise, Pitch full counter clockwise, Echo Time 8:00

Create a CV and Gate sequence (using René for example), and patch CV to ECHOPHON Pitch 2 and Gate to OPTOMIX Strike Input. The Feedback should be adjusted so ECHOPHON is on the brink of oscillations. The Damp parameter on the OPTOMIX creates more or less ambience in the sound. The Echo parameter on ECHOPHON alters to range and timbre of the sound. The ECHOPHON Pitch parameter controls the pitch of the sound.

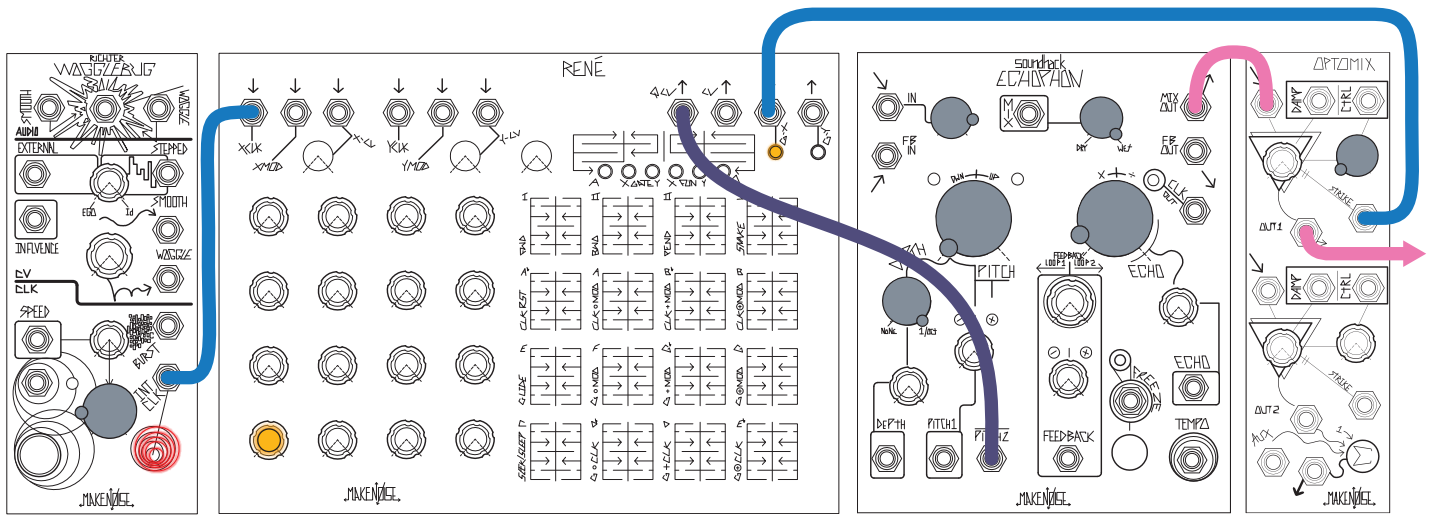

StutterPhon:

A wonderful patch for creating rhythmic variations. Mix 12:00, Depth 7:00 (no pitch shift), Feedback 2:00

Patch external Master Clock to Tempo Input. Set Echo Time to 12:00 or less for Multiple of Master Clock. Patch Gate or division of Master Clock to Freeze Gate Input or utilize Freeze Button manually to create stutter effects synchronized to multiple of master clock. Experiment with Depth setting for subtle pitch-shifting of these stutters or deep harmonizing to add counter melodies.

