

Shared System: Black & Gold, Plus



(v1.11)

Getting Started:	
FCC -----	3
Limited Warranty -----	4
About this Manual -----	5
Modular Signals and Safety -----	6
Overview of Terms:	
Patch Notations -----	7
User Interface -----	8
Signals -----	9
Types of Control Voltage -----	10
Tutorials:	
Lesson 1: Hearing a Control Voltage: -----	14
Lesson 2: Dual Prismatic Oscillator -----	19
Lesson 3: MATHS, the voltage swiss army knife -----	23
Lesson 4: Patch Away -----	27
Module Overview:	
MATHS -----	28
modDemix -----	29
DPO -----	30
Optomix -----	31
Echophon -----	32
Erbe-Verb -----	33
CV Bus -----	34
Wogglebug -----	35
Pressure Points -----	36
Rene -----	37
Phonogene -----	38
Glossary -----	39



This device complies with Part 15 of the FCC Rules. Operation is subject to the following two conditions: (1) this device may not cause harmful interference, and (2) this device must accept any interference received, including interference that may cause undesired operation.

Changes / modifications not approved by the Make Noise Co. could void the user's authority to operate the equipment.

This equipment has been tested and found to comply with the limits for a Class A digital device, pursuant to part 15 of the FCC Rules. These limits are designed to provide reasonable protection against harmful interference when the equipment is operated in a commercial environment. This equipment generates, uses, and can radiate radio frequency energy and, if not installed and used in accordance with the instruction manual, may cause harmful interference to radio communications.

makenoisemusic.com

Make Noise Co., 414 Haywood Road, Asheville, NC 28806

Limited WARRANTY:

Make Noise warrants this product to be free of defects in materials or construction for a period of one year from the date of purchase (proof of purchase/invoice required).

Malfunction resulting from wrong power supply voltages, backwards or reversed eurorack bus board cable connection, abuse of the product, removing knobs, changing face plates, or any other causes determined by Make Noise to be the fault of the user are not covered by this warranty, and normal service rates will apply.

During the warranty period, any defective products will be repaired or replaced, at the option of Make Noise, on a return-to-Make Noise basis with the customer paying the transit cost to Make Noise.

Make Noise implies and accepts no responsibility for harm to person or apparatus caused through operation of this product.

Please contact technical@makenoisemusic.com with any questions, Return To Manufacturer Authorization, or any needs & comments.

<http://www.makenoisemusic.com>

The Shared System Manual is primarily intended for Shared System owners who have not used a modular synthesizer before. It outlines the basic concepts of modular synthesis within the context of the Shared System while providing a groundwork for future learning when using the individual manuals for each module within the System. Hopefully there is something here to be learned by seasoned synthesists as well!

The Manual begins with an Overview of Terms and Concepts, followed by step-by-step walkthroughs of a few simple patches that were designed to demonstrate some of the basic musical concepts of modular synthesis. These first lessons focus on the Shared System's core modules: DPO, MATHS, and Optomix. Later in the manual, we'll show patches and basic descriptions for each module within the Shared System in order to further demonstrate potential patch techniques. Finally, at the back of the manual, you will find a Glossary of Terms.

Throughout the manual, you will also find links to a variety of educational resources we have made available, including individual module manuals, and informational videos on the Make Noise YouTube channel. Between this Manual and the other resources we've provided, you could find the answer to almost any question you may have. However, if something is still unclear, feel free to email us at technical@makenoisemusic.com and we will do our best to get back to you in a timely manner. We are here to help!

THANK YOU:

Written by Walker Farrell

Illustrated by Lee Coleman

Spiritual advisor, Tony Rolando

The signals inside a Eurorack modular synthesizer like the Shared System are **much higher strength** than typical instrument or line-level audio signals. The typical audio output of the modular synth has an amplitude of about 10 volts peak-to-peak, which is over 3 times “hotter” than that of the typical line-level signal.

One reason for this wide difference in amplitude is that not all the signals inside the synthesizer are audio signals. Many of them are control voltages, which cannot be heard directly but instead are used to control various elements within the system. The higher amplitude outputs of these signals allow them to be reliably used without significant interference from other electronic sources such as computers, appliances, radio waves, etc. Most importantly however, high amplitude signals allow for modulation across the entire range of any parameter.

The very hot/loud output signals are quite capable of damaging speakers or ears if not attenuated carefully before monitoring. Whenever connecting from the Shared System to your mixer, speaker system, amplifier, or headphones, it is recommended that you always start with the input volume at **zero** and bring it up gradually to avoid any damage.

The Shared System includes a dedicated stereo Output with a 1/4" jack and a level control that outputs at typical line level, making this process easier. Alternatively, Make Noise offers the **Rosie** module, which has similar line-level Outputs. If you do not have a CV Bus or Rosie, don't worry, just remember to watch the sound levels when you first start a session. It is also possible to connect audio outputs from modules within the system directly to inputs on a mixer or audio interface, paying close attention to the advice listed above and using a mini to 1/4" adapter cable.

Getting Started:

To power up your system, simply attach the included power adapter to the jack on the side of the case, plug it into your wall outlet, and flip the power switch to the “on” position.

Monitoring:

This manual uses the term “monitoring” to refer to the listening environment, whether it is a PA, mixer, or headphones. Any time the word Monitor is used, it means patching the respective Output to the L[Mono] Input of the CV bus. Use the Level Panel Control to set the volume.

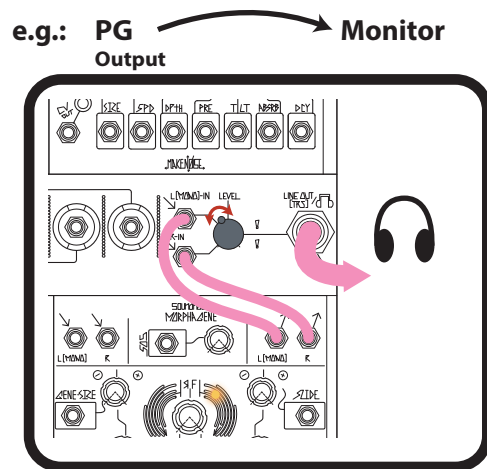

Modules:

The Shared System is an advanced modern modular synthesizer. It consists of a **case** filled with a selection of individual modules. Its interface consists of **jacks**, **Panel Controls** (i.e. knobs), **Touchplates**, **Buttons**, **LEDs** (light emitting diodes), and also **cables**, which carry **signals** from one place to another.

Each module in the system is independent and also works with the modules around it via **patching**. You can tell the identity of a module by its name, printed on the faceplate (e.g. **DPO** or **MATHS**). **Note: No module has any effect on any other module unless they are patched together. So if there are no patch cables in a module, adjusting its settings won't really have an effect on your patch.**

In this manual, patch instructions will be notated like this (the  represents a patch cable connected to the two jacks):



For example:



This is instructing you to patch the Sine Wave Output of the DPO's A oscillator to the signal input on Channel 1 of the Optomix. Don't worry if it sounds daunting, you'll quickly get the hang of it. Accompanying the written patch instructions, you'll also find small, visual representations of the connections. Continuing the example above:

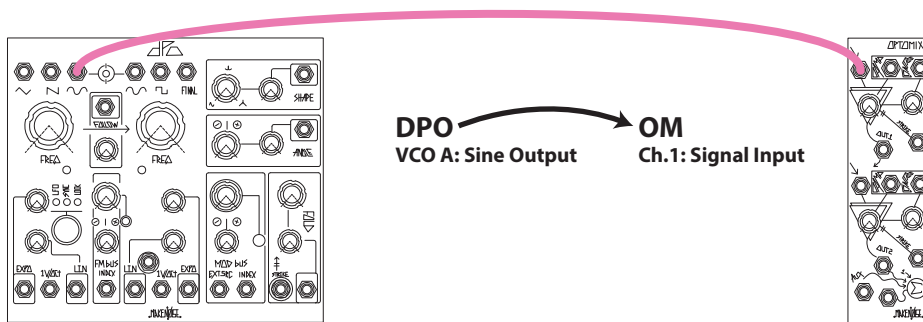

SCOPE NOTATIONS :



In this manual, patch examples are sometimes shown with an illustration that resembles the signal(s) as displayed on an oscilloscope. These drawings are for diagrammatic and/or conceptual purposes only and not intended for laboratory use. **Scope diagrams are not to scale.**

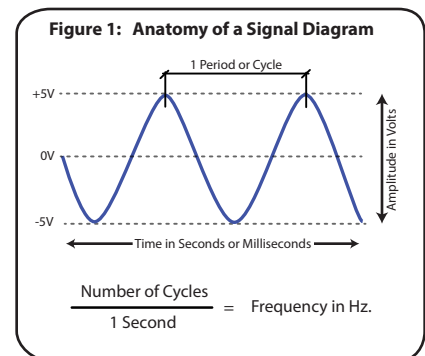

Panel Controls:

The knobs on any particular module are utilized to set values for their respective parameters. Often a value can be altered by **Control Voltage (CV)** in an input jack, which can be visualized as an invisible hand “turning” the knob. We will go into much more detail about CV, which is in many ways the defining characteristic of the modular synthesizer.

In the Shared System (Black & Gold, Plus), medium (white) knobs and large (grey) knobs are generally used for setting base values, while small (white) knobs are used to **Attenuate** (i.e. “scale”) and/or **Invert** incoming CV. Because of the complex nuances of each module, there are some slight variations in this theme, so check the “Modules” section for information about particular knobs.

Figure 2:

Common knobs shown with associated patch notation, when applicable.

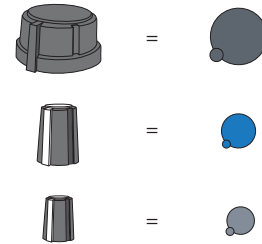

Touchplates:

Touchplates are metal surfaces on the faceplates of the **Pressure Points** and **Rene** that allow circuits to be completed when they come into contact with your fingers, essentially making you a part of the circuit. They are very useful in creating a “playable” interface with the system.

Figure 3: Touchplates

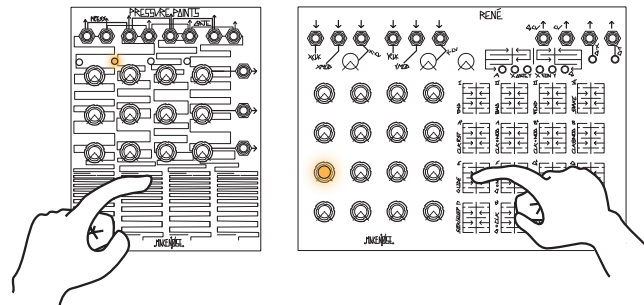

Buttons:

The MATHS, Morphogene, Echophon, Erbe-Verb, DPO, and Wogglebug also include Buttons for certain functions. Some of these functions can also operate under voltage control via gates or triggers (see ‘Signals’ section).

Figure 4: Buttons

In order to activate self-cycling functions on MATHS Ch. 1 or Ch. 4, **[PRESS]** the associated Cycle button. Self-cycling is indicated by the red LED.

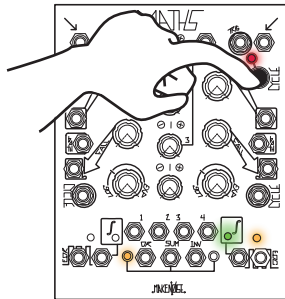

Jacks:

Every jack in the system is either an input or an output (Fig. 1.6). Jacks are patched together with cables. Simply plug one end of the cable into an input and the other end into an output. Patching an input to another input has no effect; patching an output to another output has unpredictable effects and is generally not recommended. Don’t worry though, you won’t hurt anything by patching “incorrectly,” so don’t be afraid of happy accidents...

Figure 5: Typical Jack Labels:



LEDs (Light-Emitting Diode):

With the exception of the Optomix, each module within the Shared System utilizes LEDs to indicate a variety of behaviors and conditions. Perhaps the most common use is to show the clock rate (e.g. Wogglebug); however, LEDs may also display signal amplitude and polarity (e.g. MATHS Unity Output), the Active Location (e.g. Rene), or indicate alternate modes (e.g. DPO Lock LED). **To find out more about a specific module’s LED behavior(s), consult its manual from www.makenoisemusic.com/.**

Normalizations:

The Make Noise system utilizes **switching jacks** on some of its inputs and outputs. These jacks have the capability of receiving two different signals depending on whether a patch cable is physically present. An example of this is the Ch. 3 Input jack on the MATHS. With no patch cable present, it is **normal** to a 5v signal which can then be attenuated and/or inverted with the Channel 3 panel control. Plugging a cable into this jack bypasses said signal and replaces it with whatever you patch in.

Every element of the system exists with signals in mind, whether creating, modifying or sending them. Signals interacting with one another is the heart of the way the modular system works. Signals appear at outputs and can be patched to inputs. They take the form of voltage at various levels within the range of +/-10v.

There are several basic signal types in the system. Each input tends to “expect” a particular type, but since they all take the same form (+/-10v) there are many cases where using the “wrong” type is just as useful as the “right” one. Don’t get too hung up on it. There are quite a few “gray areas” where a signal could be interpreted as more than one type depending on its use, so again, experimentation is paramount.

Here are some basic signal types, accompanied by graphical representation of voltage over time:

Audio:

Audio signals change voltage levels, or oscillate, in the frequency range that is audible to human beings. This is the type of signal that you can actually hear when you send it to your monitoring system. In some cases, Control signals can also oscillate at audio rate.

Examples:

DPO Waveform Outs, Echophon Mix Out and Feedback Out

Figure 6: An Audio Rate Sine Wave

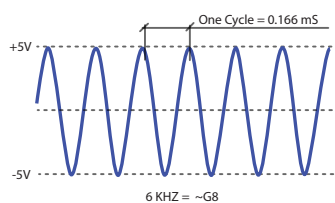

CV (Control Voltage):

The term “control voltage” refers to any continuous signal that you use to control a parameter. In many cases, CV moves at too low a frequency to be audible if amplified. Instead, you will hear the results of a CV changing an audible parameter.

Examples:

MATHS SUM Output, René QCV

Figure 7: a Low Frequency Oscillator

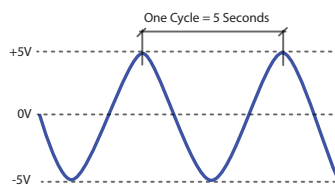

Triggers, Gates, and Clocks:

Triggers, Gates, and Clocks are used to initiate events and switch between states. Instead of being continuous like CV, they have only two states, Gate High and Gate Low. “Gate High” is usually a +8v signal whose length (in time) is variable. “Gate Low” is 0v (or no signal at all).

There are a lot of similarities between these signal types. Keep in mind, the Make Noise system responds to like signals in similar ways. A Trigger is just a very quick pulse of positive voltage. A Gate is longer, anywhere from a few milliseconds to “always on.” The length of the Gate (in time) is referred to as the Gate’s Width. Trigger and Gate inputs are distinctive in that patching to these inputs does not have a continuous effect, but only one or two possibilities (such as moving a sequence on René forward by one step, or Freezing/unfreezing the Echophon’s memory buffer). Clock Signals are like Gates and/or Triggers that “go High” at regular intervals.

Gate and Trigger Outputs are specially made to patch such inputs, but most such inputs will respond to any signal that moves from 0v to 2v or higher.

Examples:

Triggers Outputs: Morphogene EOS, Echophon CLK Out

Gate Outputs: MATHS EOC (End of Cycle), Pressure Points Gate

Clock Outputs: Wogglebug Clock Out

Figure 8: Typical Trigger Signal



Figure 9: Typical Gate Signal

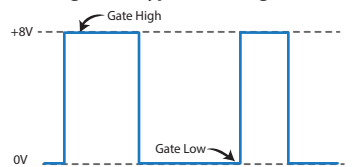
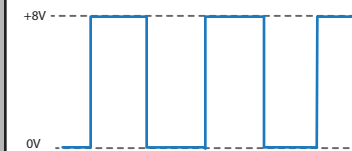

Figure 10: Clock Signal



We have gone over the difference between types of signals: **Audio**, **Gates**, and **Control Voltage**. Furthermore, there are several types of CV within the Shared System.

Functions

A function is an event that “rises” from 0v to another level (for example, 8v) over some period of time, before “falling” back to 0V again. It may or may not **Sustain** at the top, depending on how it is patched. Typically, this event is either Triggered or Gated.

A typical use for a function is to open a VCA with an audio signal in its input in order to create a discrete “note.” In the Shared System, functions may be generated with the Trigger and Signal inputs of MATHS Ch. 1 and 4, using the Rise, Fall, and Response settings to determine the length in time of each segment of the function. An example of a manually-generated function is a Pressure Output of the Pressure Points.

Users of non-modular synthesizers may be noticing that Functions share some characteristics with what are commonly called **Envelopes**. The term “Envelope” refers to the amplitude of an instrument sound over time, and its associated terms (e.g. **Attack**, **Release**, etc.) similarly originate from that concept. We prefer the broader term “Function” because it expresses to the synthesist that it can be used for any voltage-controllable parameter, including but not at all limited to the initiation and shaping of discrete notes (in fact, oscillators and LFOs can also be considered functions). See **Figures 11 and 12** to see how to patch the typical **Attack Release** and **Attack Sustain Release** envelopes using a Channel of MATHS.

The **ADSR** (Attack/Decay/Sustain/Release) and other longer envelope types can be created using multiple channels of MATHS.

Figure 11: MATHS Typical AD Function

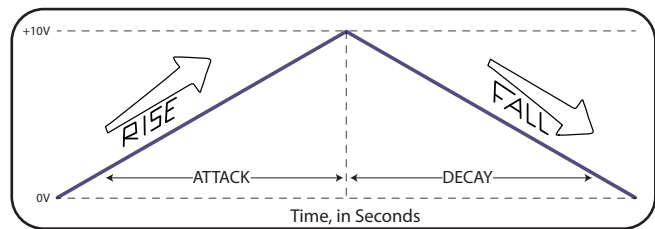
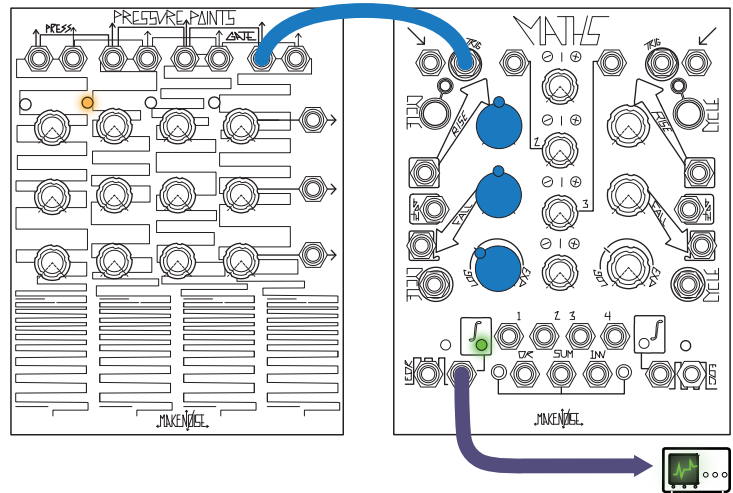

Attack Decay (AD): The function is initiated once the Gate is received at the MATHS Trigger Input. Note: Gate Length is ignored, as only the Rising Edge is “seen” by the MATHS Ch.1 Trigger Input.

Figure 12: MATHS Typical AR/ASR Function

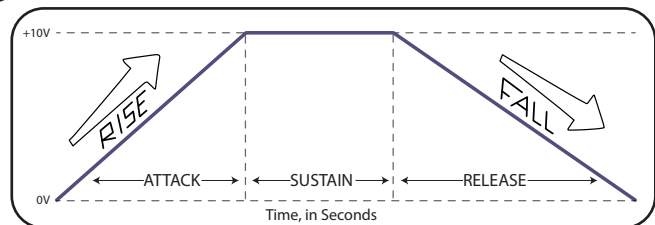
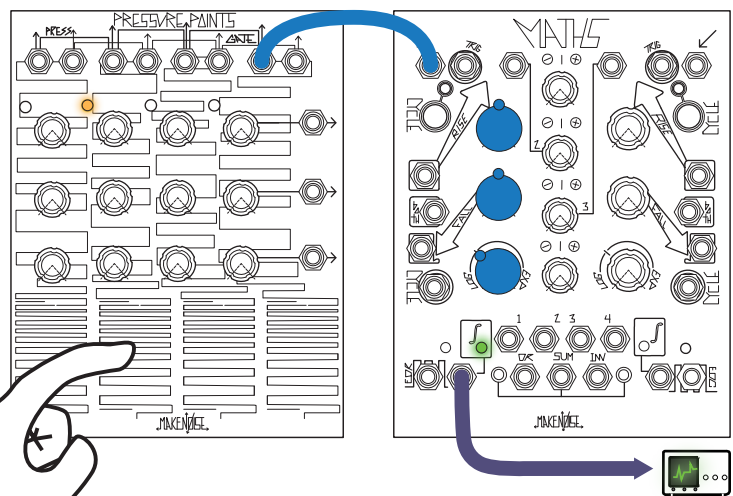

Attack Release (AR)/ Attack Sustain Release (ASR): The function “Rises” once the Gate is received at the MATHS Signal Input. If the Gate/Touchplate is held “high”, the function “Sustains” and “Falls” as soon as the Gate at MATHS Ch.1 (or Ch.4) Signal Input goes “low” again.

Random Voltage

Random Voltage, as you might have expected, is not predictable; however, it is something the user (or artist) may influence. The Wobblebug is the Shared System's Random Voltage source. It contains a **Stepped** Voltage source (similar to a Sequential Voltage but with each clock input generating a new Random Voltage), a **Smooth** Voltage source (where the values "glide" from step to step), and a **Woggle** Voltage that "chases" the **Smooth** Voltage, Woggling around whenever it catches up. In a more subtle use, Random Voltage can liven up a patch, creating shades of unpredictability. It may be used to generate unpredictable timbral shifts in predictable melodies, or it could generate unpredictable melodies with timbral and rhythmic shifts created by gestural control of the performer. It provides some voice for the synthesizer's "Id," thus allowing you to jam with the machine. At the extreme, with creative patching it can be used as the hub of self-contained generative music systems.

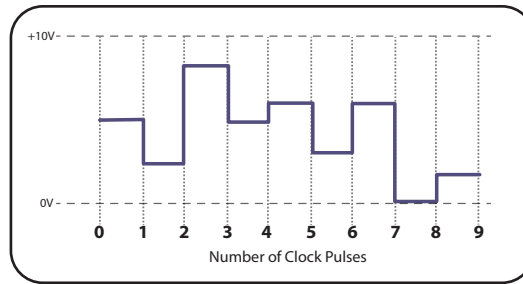
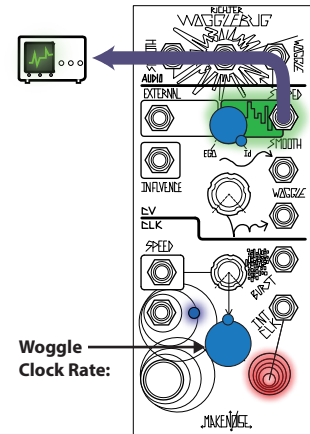

Figure 13: Stepped Random Voltage



Sequential Voltage

Sequential Voltage is a series of held voltage levels that are stored in sequential order by a sequencer. There are two sources of sequential voltage in the Shared System: René and Pressure Points. With these modules there is always one Location selected: the Active Location's Stored voltage (level set by the associated knob) appears at the associated output(s). The touchplates give manual access to these locations and with the René Locations, can also be accessed sequentially via Clock (a Gate or Trigger at one of the clock inputs). Typical use of Sequential Voltage is to play a melody by patching it to the 1V/OCT input of a VCO. This could be done via clock to create an easily repeatable or variable sequence, or played manually via touchplates, in the manner of a keyboard. However, sequencers are not only for notes! They are also excellent for creating arbitrary modulation patterns for timbre, timing, and even modulation depth!

Figure 14: Sequential Voltage

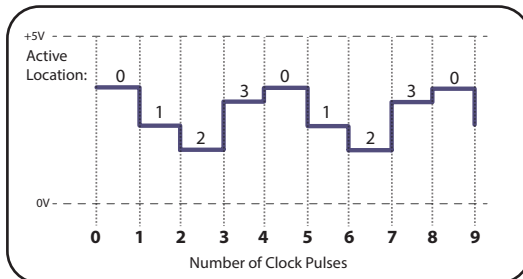
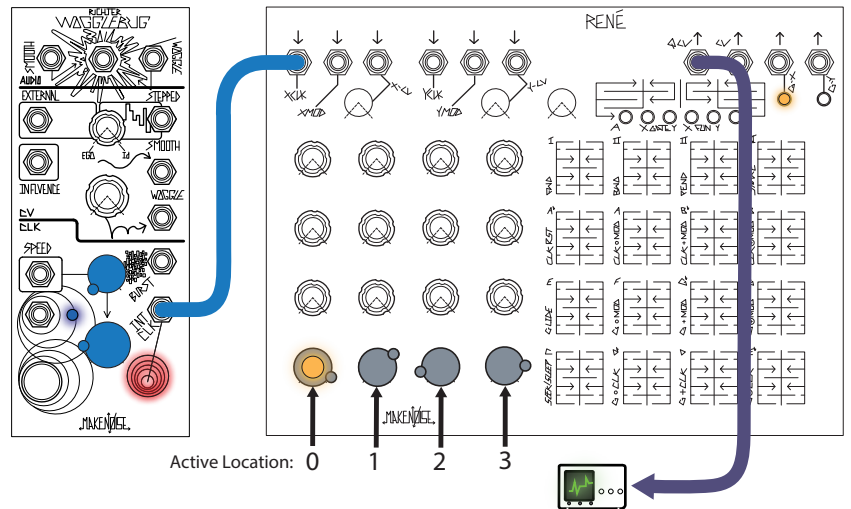

7. The Pressure Points can also be accessed via clock using the optional BRAINS expansion module, which does not come standard with the Shared System.

LFO (Low Frequency Oscillator)

The LFO is essentially a triggered function that retriggers itself each time it ends. It is often used as a constant modulation source in order to produce vibrato, tremolo etc. In the Shared System, a cycling channel of MATHS can generate a simple variable-shaped LFO. More complex LFOs can be created by combining channels in various ways. The DPO also contains an LFO in VCO A, which can be set to low frequency (all its waveforms are available simultaneously). One difference to keep in mind between a cycling MATHS and a DPO is that the MATHS cycle is a **unipolar signal** (either 0v to 10v or 0v to -10v, depending on the position of the channel's level attenuverter) while the DPO is **bipolar** (+/-5v).

Unipolar and Bipolar Voltages:

Unipolar voltage, in other words voltage that is positive only, causes modulation that "rises," starting from the position of the Panel Control for the parameter that is being modulated. Since you can set the bottom "endpoint" using the Panel Control, unipolar voltage is easier to use for precision modulations. For example, for inputs with an **Attenuator**, you can set the top "endpoint" for modulation depth. On inputs with an **Attenuverter**, you can change the direction of modulation, such that the Panel Control sets the top "endpoint" and when the **Attenuverter** is set to -, the position sets bottom "endpoint," causing the modulation to act in reverse.

Bipolar voltage oscillates from positive to negative, modulating "around" the position of the Panel Control. It is possible to set the Panel Control near maximum or minimum to "clip" portions of the modulating signal.

Figure 15: MATHS: Unipolar LFO

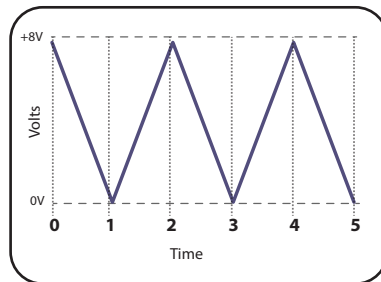
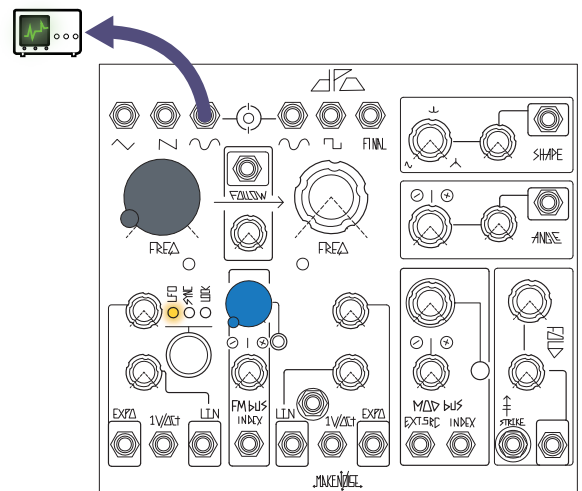
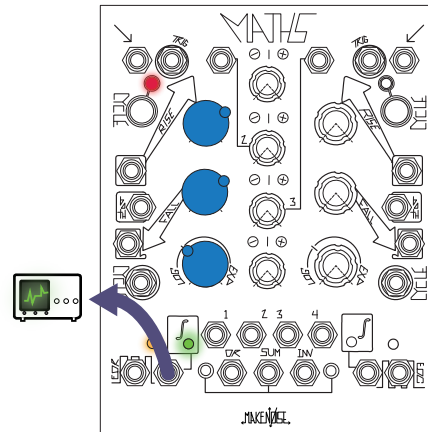
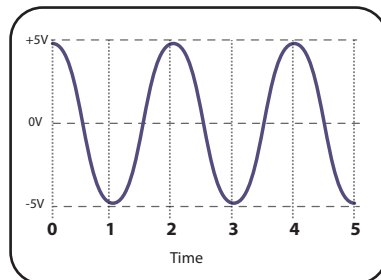

Figure 16: DPO: Bipolar LFO



Unipolar Control Voltage: "Range"

Now that we've discussed the use of Control Voltage to manipulate parameters over time, it is important to introduce the concept of attenuation to control the range of movement.

Using the same unipolar Control Voltage from MATHS illustrated on the previous page, you can see how we can control the range and direction of modulation in relation to the Echophon's Pitch Panel Control setting simply by adjusting the position of the Pitch Input Attenuvortor. This has the effect of manually rotating the Pitch Panel Control knob over time, starting with the initial Panel Control setting.

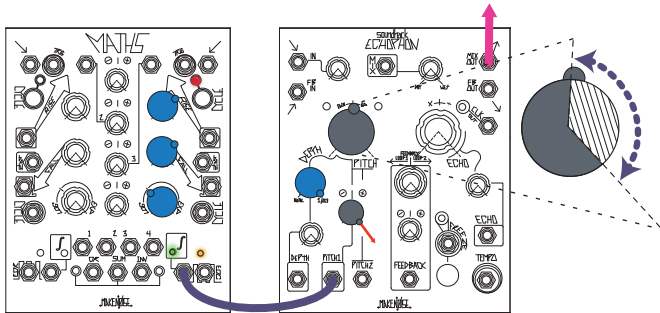

Figure 17: Adding the MATHS unipolar voltage to the Echophon's Pitch Panel Control knob. The resulting "range" of movement is indicated by the crosshatched area of the Pitch Panel Control.

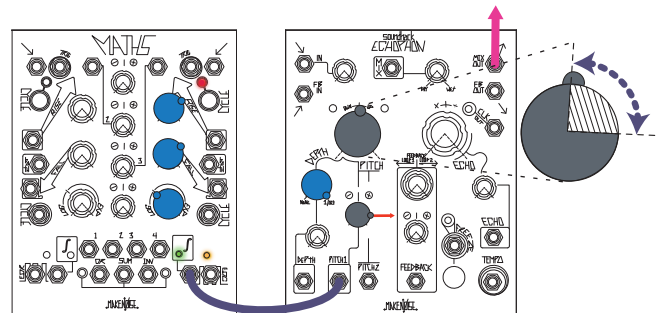

Figure 18: Adding the MATHS unipolar voltage to the Echophon's Pitch Panel Control Offset. The resulting "range" of movement is indicated by the crosshatched are of the Pitch Panel Control.

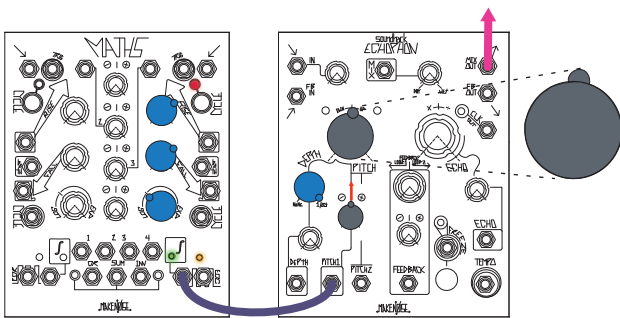

Figure 19: With the Pitch1 Input Attenuvortor set to 12 o'clock, no voltage is added to the Echophon's Pitch Panel Control setting and therefore does not move.

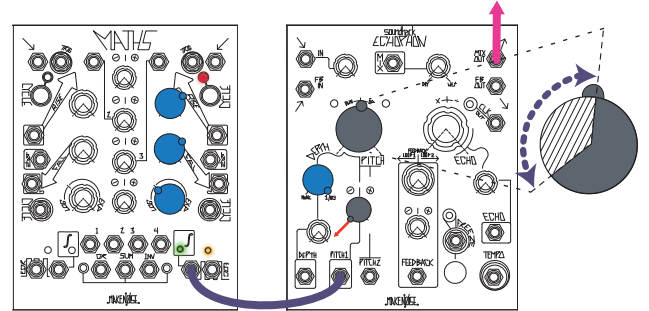

Figure 20: Subtracting the MATHS unipolar voltage to the Echophon's Pitch Panel Control Offset, using the Pitch1 Input Attenuvortor to invert the signal's polarity. The resulting "range" of movement is indicated by the crosshatched are of the Pitch Panel Control.

Bipolar Control Voltage: "Range"

Using the same bipolar LFO from the previous page, you can see how the Echophon's Pitch 1 Input responds differently than the unipolar voltage from the examples above. The primary difference is that bipolar voltages, when added to a Panel Control offset voltage, cause modulation to move the parameter in **BOTH** directions over time from the Panel Control knob setting.

This is because the Echophon's Panel Control offset voltage is always positive. That means whenever the negative portion of DPO's LFO cycle is added to Echophon's Panel Control offset voltage, it is actually "subtracted" from the value, which has the effect of manually turning the knob counter-clockwise.

What happens when you invert the Control Voltage?

Figure 21: CV Range

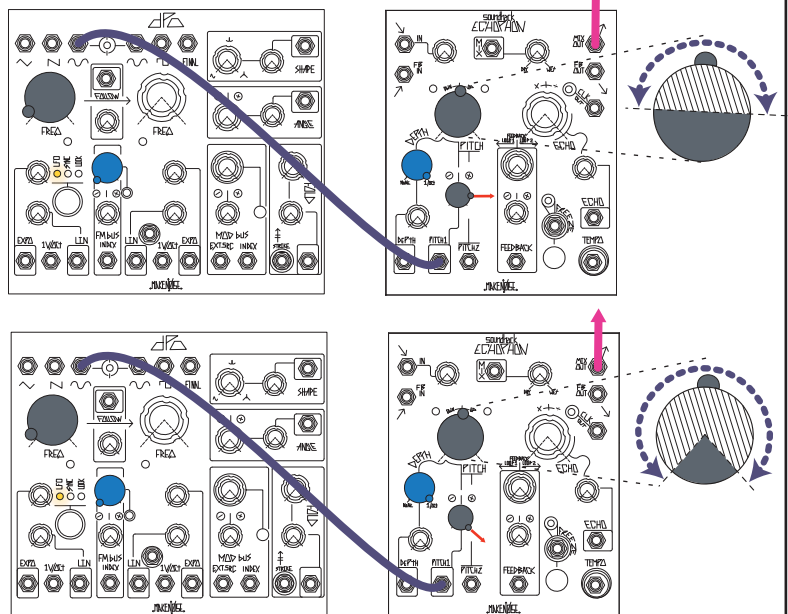

Here are a couple walkthrough patches to help develop your understanding of the system and to get you started on creating your own sounds.

The tutorials cover the basic use of the core modules of the system: DPO, MATHS, and Optomix and provide an introduction to the use of Control Voltage.

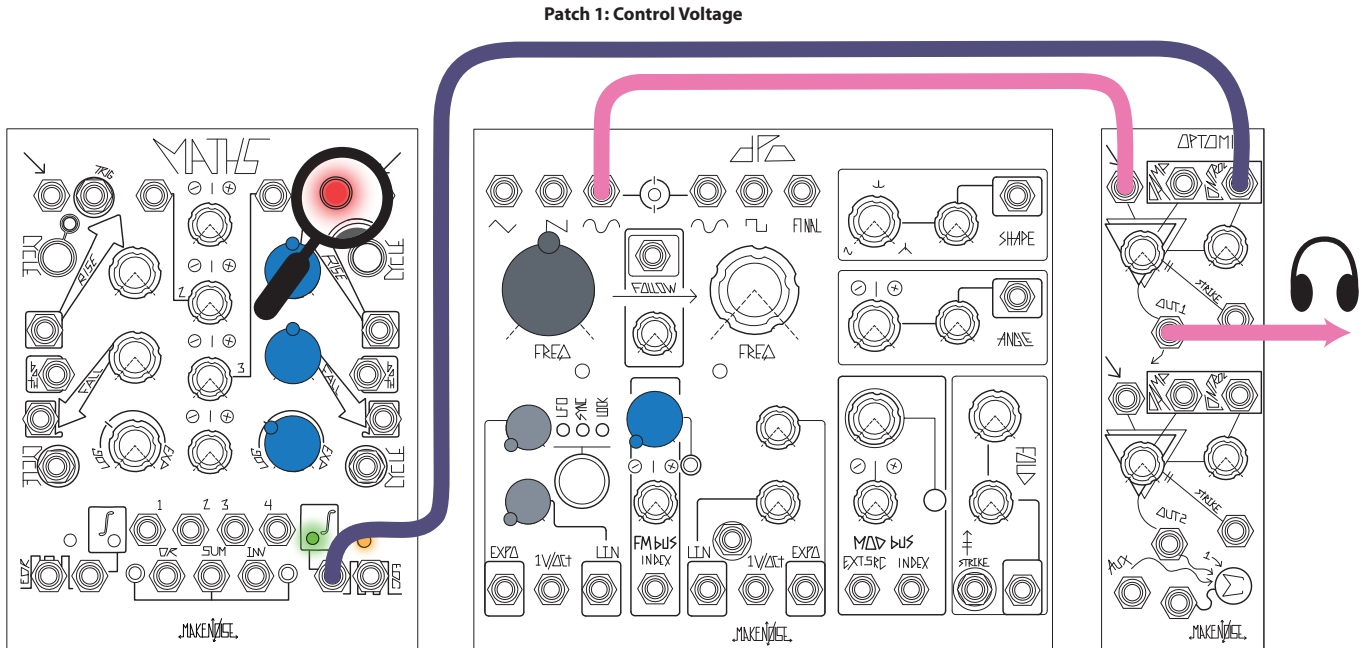

Tutorial 1: "Hearing" a Control Voltage:

Start by having a look at the **DPO**. This is the primary sound source of the Shared System. It is a dual oscillator, so think of the two "sections" around the big grey knobs as **VCO A** and **VCO B** (VCO = Voltage Controlled Oscillator). The section on the far right is the **"FINAL OUT"** section, which we'll talk about later.

Each VCO oscillates at a base frequency determined by its FREQ knob (the grey knob) and Fine Tune potentiometer, and simultaneously outputs several different waveforms at that frequency (the jacks at the top labeled with wave-shapes). There is also an **FM Bus** in the middle that allows the two VCOs to control each others' frequency dynamically. To start, find the Medium knob in the middle between the two oscillators. This is the **FM Bus Index**. As you turn it up, you'll see the LED light up next to it to show the value increasing. For now, let's turn it all the way down (fully counterclockwise, or **CCW**) so that the oscillators are independent. You'll see the FM Bus LED go dark as you turn it all the way down.

Now turn the VCO A FREQ knob to about 12 o'clock a midrange frequency. There's a button below this knob that allows you to select its mode. Press it and you'll see it cycling through the LED indicators for LOCK, SYNC, and LFO modes. For now, let's keep it in "normal" mode, so press the button until none of those LEDs are lit.

Okay, time to patch...

What is an oscillator?

An oscillator outputs repeating voltage in the range of -5v to +5v. The core of the DPO generates voltage that ramps up in a straight line and then back down, creating a triangle shape. The other waveform outputs are created by using circuitry to mold the triangle into other shapes, each of which has a unique sound. The frequency of oscillation determines the pitch: the higher the frequency, the higher the pitch.

An oscillator is ALWAYS oscillating: the only thing that stops it is powering down the system.

The DPO contains two oscillators that can be controlled independently or together.

Figure 22:
DPO VCO A Triangle Oscillator Core

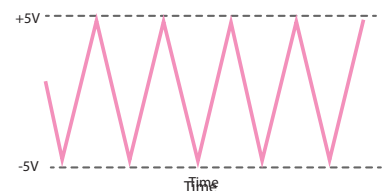

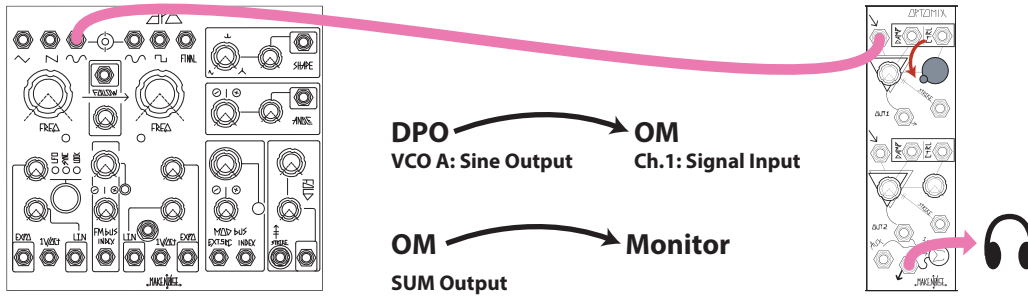

In case you missed the explanation above or need a refresher, this diagram is instructing you to patch the SINE Output of VCO A (it's a curvy wave, as opposed to the pointy triangle and sawtooth) into the Signal Input of Channel 1 of the Optomix (the top left jack). Now, Adjust the Optomix's Ch.1 Panel Control (top right knob) to full CCW.

The SUM Out is the bottom right jack on the Optomix, just above the Make Noise logo. Send it to your monitoring system, as detailed in the "Getting Started" section. Wait... don't hear anything? Gradually turn up the Ch1. Panel Control and you should hear a clean, constant tone: a sine wave.

Try turning the DPO VCO A FREQ knob up and down to hear the full range of the oscillator. As you can hear it goes from really low, so low you can't even hear it, to really high, so high you might not be able to hear it.

What you're probably wondering is, how can you turn that constant tone into a series of notes with beginnings and endings? One way is to just turn the Optomix's Channel 1 control up and down over and over again, but that would probably tire you out pretty quickly. Let's start bringing some **CV** (Control Voltage) into the mix.

What is a VCA?

A VCA uses one signal to control the amplitude of another.

Figure 23:
VCA Response to Unipolar Control Voltage

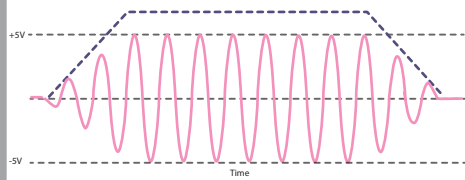

The Control Signal is an Envelope (0-5v), the Audio Signal a Sine wave (+/-10vpp). The result at the output is a Sine wave whose amplitude is controlled by the envelope.

Figure 24:
VCA Response to Bipolar Control Voltage

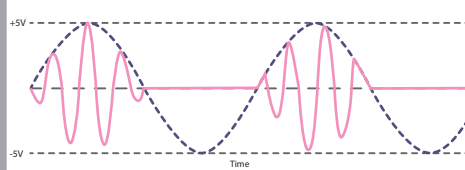

The Control Signal is now a low-frequency Sine wave (+/-5v), the Audio Signal is also a Sine Wave (+/-10vpp). Note: the Negative portion of the Control Signal has no effect, as the amplitude of the signal cannot go below zero.

To that end, let's take a look at the MATHS. MATHS consists of four channels of either voltage creation or modification, depending on how it is patched. Set all four channel panel controls (the white knobs down the center) to 12 o'clock. Also, set the Optomix Ch. 1 Control all the way up (full CW).

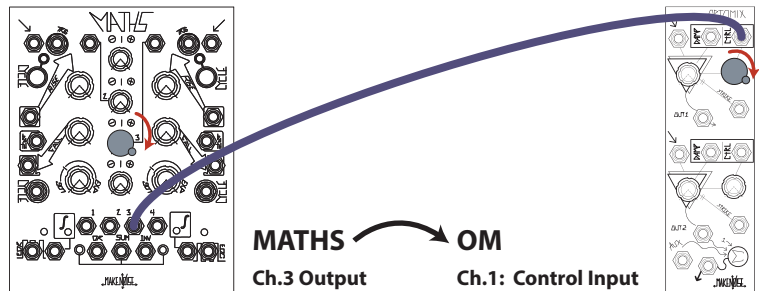

Channels 2 and 3 of MATHS generate voltage **Offsets**. An Offset is a constant voltage at a level set by the panel control. As you turn up the panel control for MATHS Ch.3, its Offset goes from 0v up to +5v, and you should hear a resulting increase in the amplitude of the sound going through the Optomix. (Note: this Offset is only generated if there is NO patch cable in the MATHS Ch.3 Input.)

The Optomix is a **Low-Pass Gate**, which is a particular type of **VCA (Voltage Controlled Amplifier)**. What this means is that it can change the amplitude (i.e. "signal level" or "volume") of the signals in its inputs using control voltage. A control voltage of zero in its Control Input(s) results in an amplitude of zero. As the control voltage goes up, so does the amplitude. (If you don't hear anything, make sure the Optomix Control knob is all the way up, and that there is nothing patched to the MATHS Ch.3 Input.)

Now, turn the Ch. 3 Panel Control back to Noon and then all the way CCW. This sends its value from 0v to -5v. Note: that the Optomix's Control Input is a unipolar input. The minimum amplitude of the signal going through the Optomix is Zero, so Control Voltages below 0V are ignored and the Outputs of the Optomix stay silent (**Figure 26**).²

So far, what we have achieved is not a whole lot different from just turning the Optomix Control. However, this patch demonstrates the concept of Control Voltage and how it allows one module to control the parameters of another.

Let's try something a little more exciting. Remove the patch cable from MATHS Ch. 3 Output and place it in Ch. 4 Unity Output:

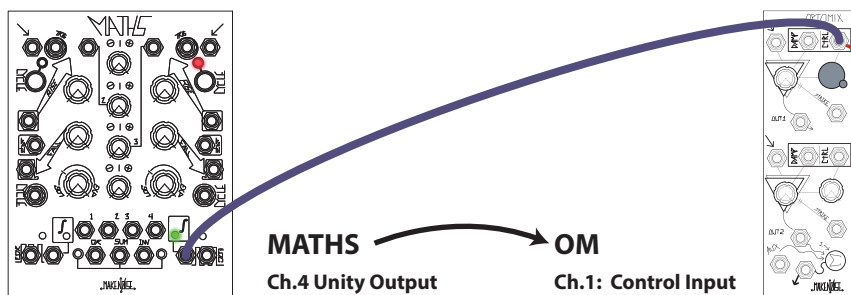

Have a look at the CYCLE button for MATHS Ch. 4. It has a Red LED next to it to indicate whether the Channel is **Cycling**.³ If it's not, [PRESS] the Cycle button.

The three Medium White knobs on the right side of the MATHS set the Rise time, Fall time, and Response (i.e. the shape of Rise and Fall) of the cycle. Try setting Rise and Fall to 12 o'clock and Response to Linear (there is a tick mark indicating this around 11:00). You should hear the amplitude of your Sine wave going up and down in time with the MATHS cycle. Try reducing the Rise time to zero by turning the Rise Panel Control fully counterclockwise. This results in the amplitude going from minimum to maximum so quickly that it lends a percussive quality to the sound. **This is a good example of how voltage control may exceed the limits of what is possible when using Panel Controls manually.**

The really wonderful thing about control voltage is that it can be used for anything...

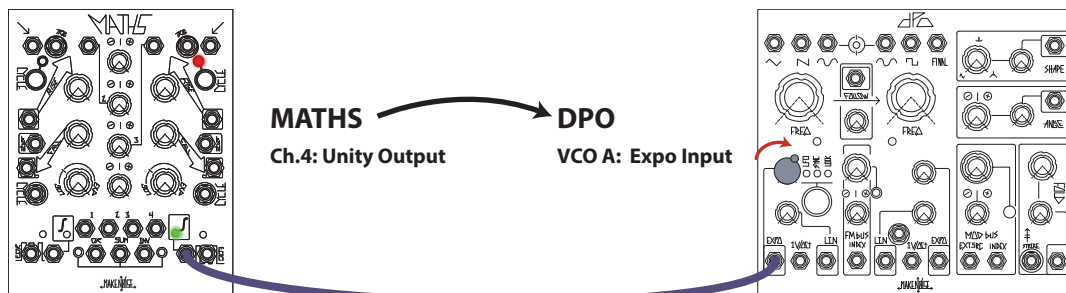

²There is such a thing as a *thru-zero* VCA, which will respond to negative control voltage by inverting the signal going through it. The modDemix is such a module. If you feel inspired, you could try this same patch with the inputs and controls of the modDemix instead of the Optomix, and see how it responds differently to negative control voltage. We will go further into the modDemix later in the manual.

³ CYCLING is very similar to oscillation, but unlike the oscillators in the DPO the Cycle of MATHS can be turned ON and OFF, either manually or by voltage control. Whereas, the DPO oscillator is always "ON."

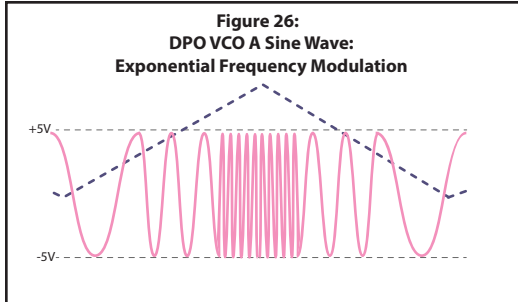
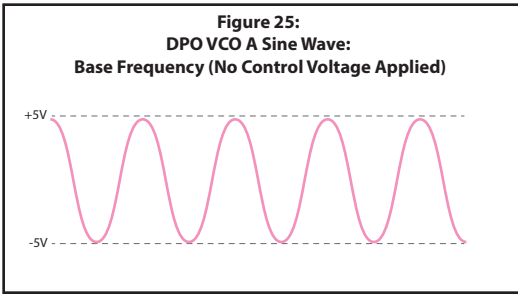

You should now hear the Sine wave changing frequency in time with the MATHS Cycle (**Figure 26**). If you don't hear any change, follow the line from the EXPO jack to its associated input **Attenuator**, which controls the amplitude of the CV source as it is applied to the destination. As you turn it up, the Modulation Depth will increase, causing greater sweeps in frequency. The position of the grey FREQUENCY pot for VCO A will have a big effect on the sound, as it sets the base frequency from which modulation starts (**Figure 25**).

Attenuation

To Attenuate a signal is simply to decrease its amplitude. Attenuating an Audio Signal has the effect of making the signal softer/quieter. Attenuating a Control Voltage signal has the effect of decreasing the Modulation Depth, reducing the amount of effect the source signal has over the destination.

Examples

DPO has Shape, Angle, and Fold Attenuators, each of which control the Depth of Modulation to its respective parameter. For CV input Attenuators, zero amplitude is at full counter-clockwise and results in no modulation regardless of the signal input.

Figure 27:
Wobblebug: Random Stepped Voltage

Figure 28:
Wobblebug: Random Stepped Voltage
(Attenuated by MATHS Ch.2)

For a variation, try patching the MATHS Ch. 4 Variable Output instead of the Unity out. The Variable Output is simply labeled "4" and is controlled in amplitude by the lowest of the four small, white knobs. Turning this knob to maximum should give you the same response as the Unity Output, but note that turning it to 12 o'clock is zero amplitude, and then further clockwise **inverts** the control voltage, meaning that it will start to Modulate frequency *downward* rather than upward from the setting of the frequency Panel Control.

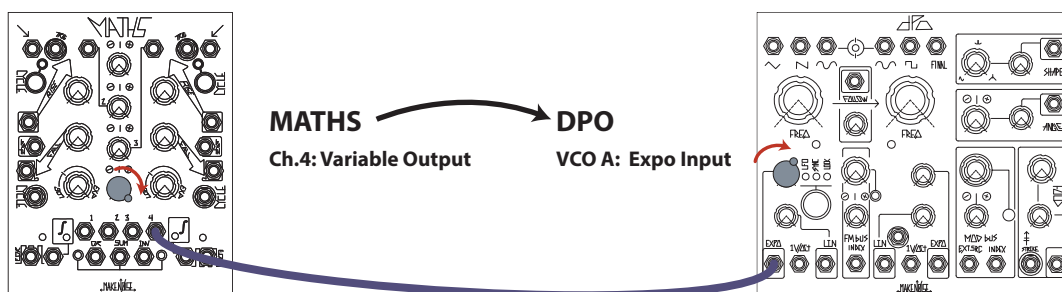

Inversion

To invert a signal is simply to turn it "upside down." For example, inverting a +5v offset results in a -5v offset. Inverting a positive-going sequence (Figure 30) results in a negative-going sequence with the same "intervals" between steps. When applied to a melody, this is a classic technique of Counterpoint.

Inverting audio signals has no effect on their sound in most cases, except for when mixing them with related signals, or when inverting them multiple times per cycle (ring modulation). Inversion can be put under voltage control using the modDemix.

An **Attenuverter** allows a signal to be inverted or non-inverted at a user-definable percentage of its original amplitude, with Zero at 12:00. Many CV inputs in the Shared System have onboard Attenuverters in order to easily Modulate a parameter in either direction, at any depth.

Example:

The Feedback CV input on the Echophon has its own Attenuverter (note the + and - symbols).

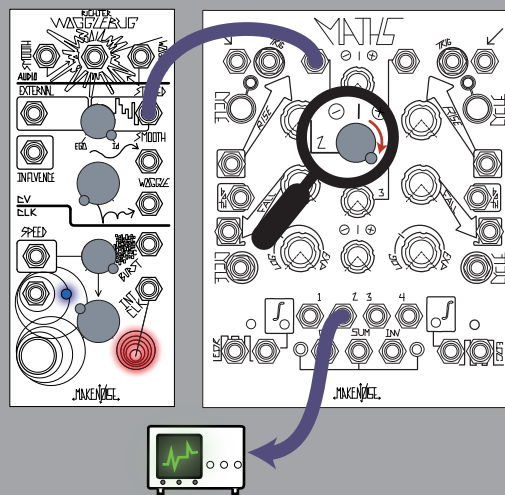

Figure 29:
Wobblebug: Random Stepped Voltage

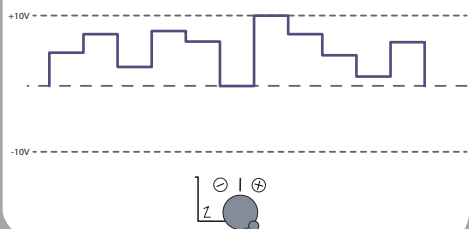
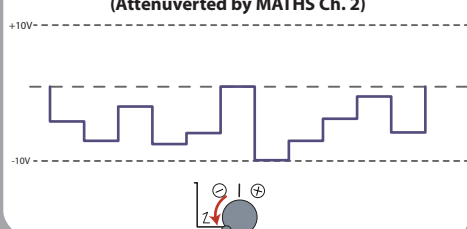
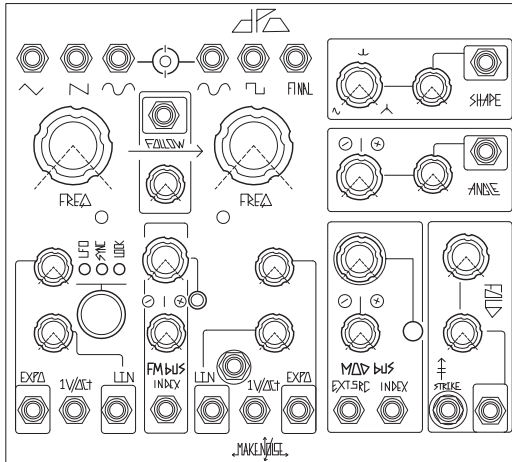

Figure 30:
Wobblebug: Random Stepped Voltage
(Attenuverted by MATHS Ch. 2)





The DPO, as previously mentioned, is the primary sound source of the Shared System. It contains two voltage-controlled oscillators (VCOs) that are both independent and related. The two oscillators each have their own section on the faceplate, VCO A on the left and VCO B on the right. The two oscillators have identical cores, but some differences in function.

Frequency Modulation (FM):

Frequency Modulation is exactly what the name seems to describe: modulating the frequency, such as that of an oscillator, using a control voltage.

Technically, any such control is FM (patching a sequence to the 1V/Oct Input on the DPO, for example). However, the phrase **FM Synthesis** usually refers to **audio-rate FM**, in other words using at least one audio-rate oscillator to modulate the frequency of another. This practice results not in a melodic sequence of pitches, but rather in a change in *timbre*.

More on FM:

The DPO is laid out to make FM very fast to perform using its internal **FM Bus**. On each of its VCOs, there are two CV inputs labeled "**LIN**" and "**EXP**". Any signal patched to one of these inputs will modulate the VCO's frequency at a Depth set by the associated input Attenuator. For example, patching a Sine wave from VCO A to the **Linear FM** input on VCO B will cause VCO B's frequency to move up and down at the same rate as VCO A's Sine wave. Since it happens at audio rate, the human ear will hear this modulation as an immediate difference in timbre rather than a continuous modulation of pitch. As the Attenuator is turned up, the Depth of Modulation gets higher and the timbral shift becomes more pronounced. At maximum, it is slightly overdriven which can actually start to warp the perceived pitch of the oscillator.

Figure 31: DPO: VCO A Simultaneous Waveform Outputs

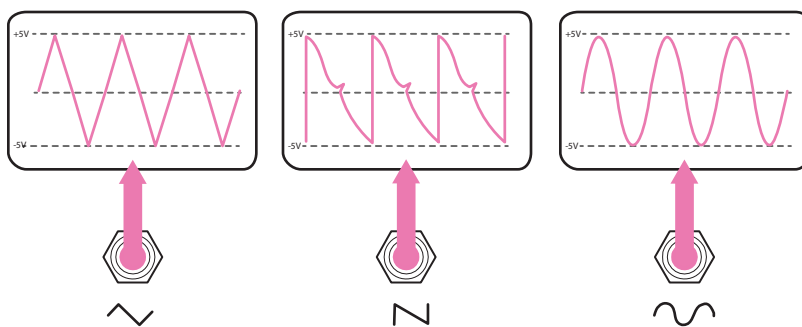

VCO A

VCO A's Output waveforms include Triangle, Sawtooth and Sine. Patch each Output in turn to your monitoring system to hear the differences in timbre (**don't forget to start with the volume on your monitoring system set as low as possible, then turn up gradually to taste**). When used at lower frequencies, Triangle and Sine waves make great modulation sources. At higher, audio-rate frequencies, Sine and Triangles respond beautifully to FM. Sawtooth is a classic wave for "subtractive" synthesis. It has an aggressive sound that also responds well to being **Hard-Synced** (see Figure 34).

Figure 32: DPO: VCO A Linear FM

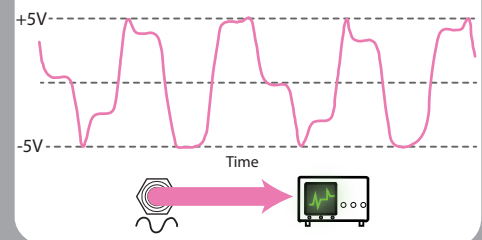

The Exponential FM Input has a different response: the Modulation Depth is more drastic the higher the input voltage. Thus, the response is greater to positive CV than it is to negative CV: the negative portion of the modulating waveform does not slow the VCO down by nearly as much as the positive half speeds it up.

Figure 33: DPO: VCO A Expo FM

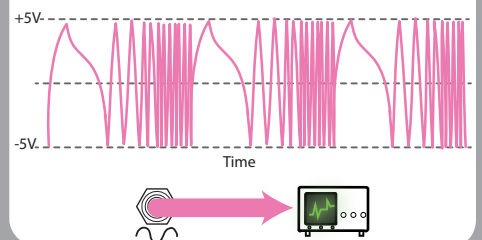

VCO A: Modes of Operation

VCO A has additional operating modes selectable by the button underneath the fine-tune control. Mode is indicated by the three LEDs: when no LED is lit it is in standard audio free-run mode, just like VCO B.

SYNC (Hard-Sync)

SYNC is a classic synthesizer programming technique in which one oscillator “resets” at the same time as another. Traditionally, this has been used to create aggressive, biting synth leads.

The DPO allows for easily syncing of VCO A with VCO B. When VCO A is a higher frequency than VCO B, this causes it to reset more than once per cycle which results in a change in its waveshape outputs. Since VCO A resets with VCO B, it will have the same apparent pitch as VCO B. Thus it is possible to control VCO A's pitch with VCO B's frequency. Changing VCO A's frequency becomes a timbral control instead, changing the relative location of the reset point and thus the shape of the output waveform.

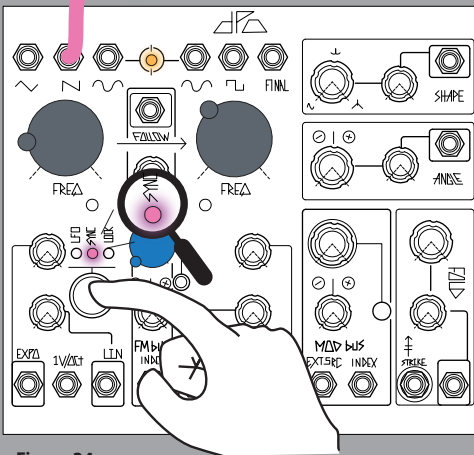
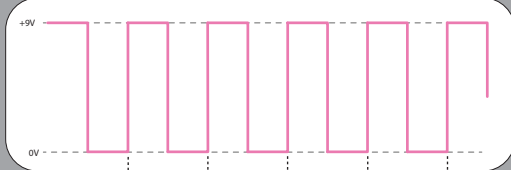

Figure 34: VCO A: Sawtooth Wave Output (Before Sync Is Engaged)



VCO B Square Wave Output



VCO A Sawtooth Wave Output (Sync Engaged)

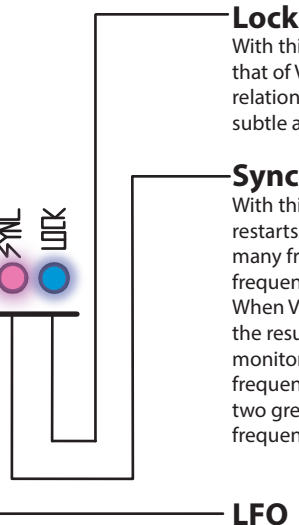
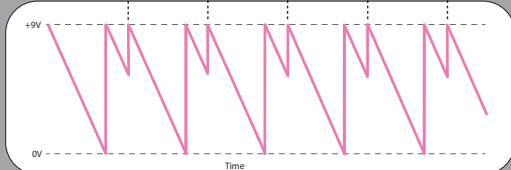

Lock

With this mode enabled, VCO A will adjust its frequency to match that of VCO B if the two frequencies are close to an integer/harmonic relationship. The effect of this behavior, also known as **Soft Sync**, is subtle and most useful for tuned FM patches.

Sync

With this mode enabled, VCO A is forced to restart every time VCO B restarts. This behavior, also known as **Hard-Sync**, means that in many frequency relationships, VCO A will sound at the same frequency as VCO B even if the core is running at a different speed. When VCO A's frequency is changed while VCO B's stays the same, the result will be a timbral shift (see sidebar). To hear this in action, monitor the SAW Output of VCO A, engage Sync mode, set both VCO frequency controls to about 10 o'clock, and try adjusting each of the two grey knobs independently to hear the effects on VCOA's frequency and timbre.

LFO

With this mode enabled, VCOA oscillates at a much lower frequency, too low to be heard directly as a discernible pitch. If you monitor it you will hear only clicks and pops. Instead, VCO A now acts as an excellent control voltage source, perfect for slower modulations of parameters. Try the patch on page 21 as an example.

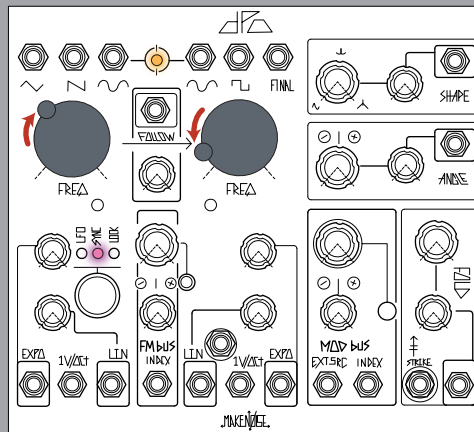
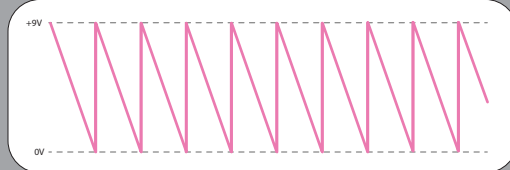
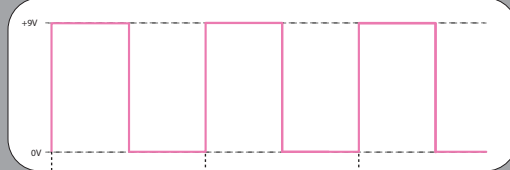

Figure 35: VCO A: Sawtooth Wave Output (Before Sync Is Engaged)



VCO B Square Wave Output



VCO A Sawtooth Wave Output (Sync Engaged)

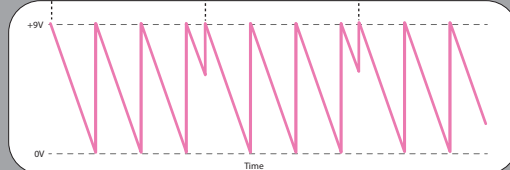

VCO A also has a behavior called **Follow**, accessed via the Follow Panel Control and CV input between the two grey frequency knobs. When Follow is turned up all the way, VCO A will “follow” any Control Voltage signal present in VCO B's 1V/Octave CV input.

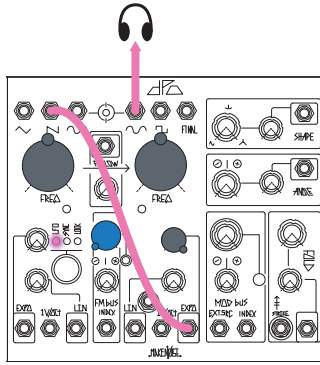

- Engage LFO on VCO A**
- VCO A SAW -> VCO B Expo FM In**
- VCO B Sine -> Monitor**
- Adjust FM Bus Index panel control Full CCW.**
- Adjust both frequency knobs to ~12:00.**
- Adjust VCO B Expo FM Input attenuator gradually clockwise.**

You should hear the Sawtooth wave modulating the frequency of VCO B. Try adjusting the frequency of VCO A. You will hear the modulation speed up or slow down depending on the position of the Frequency Panel Control(s). Try different outputs from VCO A for different modulation “flavors.” For instance, Sawtooth rises abruptly and then ramps down slowly, whereas, Triangle and SINE shapes rise and fall at similar rates.

- Disengage LFO on VCO A**
- Remove patch cable from Expo FM IN.**



FM bus

The internal **FM bus** is hardwired for the SINE wave of VCO A and VCO B and makes use of the Normalization Switch found on the mini-jacks, so with nothing patched to the Linear and/ or Expo FM inputs the associated Attenuator sets the final index of FM applied to each destination. As you increase the Index Level, the Amplitude of VCO A Sine bussed to VCO B Linear FM and Expo FM Inputs is increased. At the same time, the Amplitude of VCO B Sine bussed to VCO A Linear FM and Expo FM Inputs is increased. Therefore, you could have different amounts of Linear and Expo FM in BOTH directions all at once. At greater than 90% Index, all of the FM bus lines (Linear, Expo for both VCOs) go into overdrive when the associated attenuators are set to beyond about 80%. The FM overdrive combined with the Bi-Directional **Dynamic FM** results in some extreme Circular FM capabilities. These sounds will get out of hand quickly. The key to controlled FM within the DPO is attenuation, since setting the Index to 100% really does push the circuit to its limits.

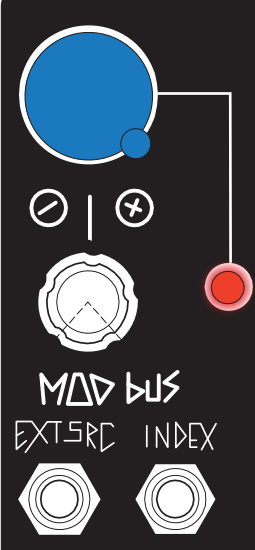

Mod Bus

The internal **Mod Bus** SOURCE is hardwired for VCO A SINE wave, with the power to use any external source by patching to the EXT. SouRcE Input. The MOD bus system makes use of the Normalization Switch found on the mini-jacks, so with nothing patched to the Shape, Angle, and Fold CV inputs, the associated attenuator sets the final amount of modulation applied to the destination. As you increase the Index level, the amplitude of VCO A Sine bussed to the SHAPE, ANGLE, and FOLD jacks is increased. Therefore you could have different amounts of modulation at each of the destination circuits: SHAPE, ANGLE, and FOLD. See page 22 for descriptions of these parameters and how each affects the DPO’s FINAL Output.

VCO B

VCO B's output waveforms include Sine, Square, and FINAL. The Sine Output is identical to that of VCO A (but its frequency is controlled independently). The Square is another classic waveform for **subtractive synthesis**. The FINAL Output is the real powerhouse of VCO B and has a world of timbre in and of itself even before modulation and processing.

Let's start there.

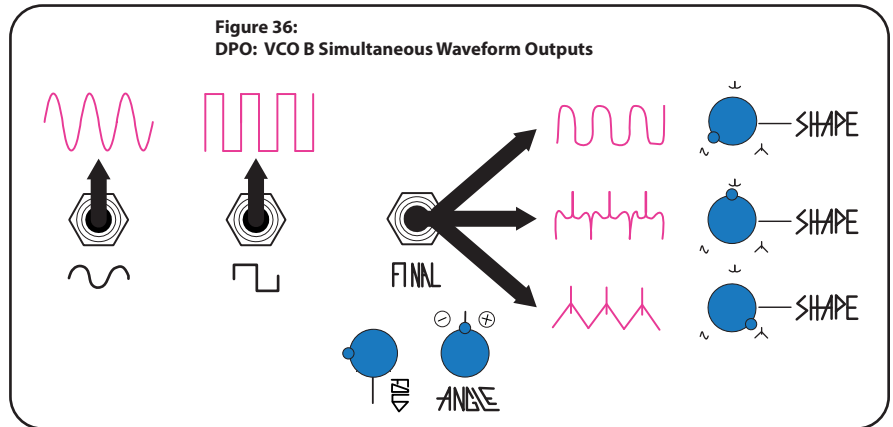

Final Out -> Monitor

First, make sure the **Mod Bus Index** (see page 21) Panel Control is set full CCW. Like the **FM Index**, it has a red LED that goes dark to indicate that it is currently off/inactive. We want it off – for now.

Set **SHAPE** and **FOLD** full CCW, and **ANGLE** to noon. Turn the **FOLD** panel control through its entire range. What you are hearing is the Sine wave (VCO B) being amplified as the knob turns up, but with a twist: instead of *clipping* (distorting) the top and bottom of the wave when it reaches full amplitude, the waveform “folds” over on itself, adding **harmonics** to the sound. You might be able to hear each new harmonic being added as the wave folds. By 12 o'clock on the panel control, there are three folds, and by full clockwise, there are five. This is the opposite of what happens in a Low Pass Filter (the type commonly found in monosynths). Rather than starting with a signal that has many harmonics and subtracting them from that signal using a Filter, the DPO Final Output starts with a signal that has almost no harmonics-- the Sine wave, and adds harmonics by folding the signal over on itself.

The **ANGLE** panel control changes the phase relationship of the folds. Try setting FOLD to 12 o'clock and then adjusting the ANGLE control slowly to hear the effect. This parameter is designed to be modulated, rather than to maintain a static parameter adjustment.

SHAPE determines the shape of the waveform that is sent through the Wave Folder. Above, we heard the Sine wave with SHAPE at counter clockwise. As the panel control moves further clockwise, the Sine wave will gradually be shaped into a small Spike and then into a Triangle with a spiky glitch in the middle. The different shapes, in addition to having different sounds on their own, will sound different when FOLD'ed and ANGLE'd: the Sine and Triangle are most dramatic through the FOLDER, while ANGLE modulation sounds most dramatic on the Spike and Triangle waveforms.

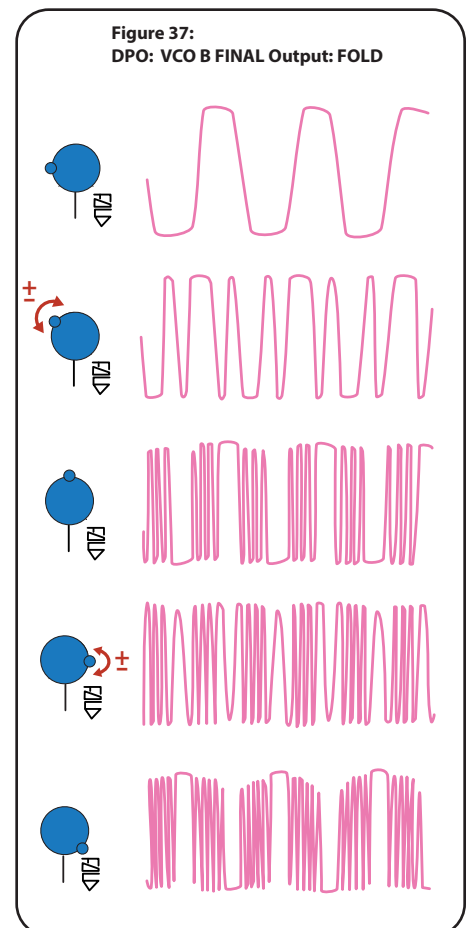

Tutorial 3: MATHS, the voltage Swiss-army knife

MATHS is the control-voltage hub of the Shared System. It is very powerful for both generation and manipulation of CV. Its layout, flexibility and versatility have led many users to characterize it as a sort of “Swiss-army knife” for modular signals.

Figure 38:
MATHS: Channel Designation

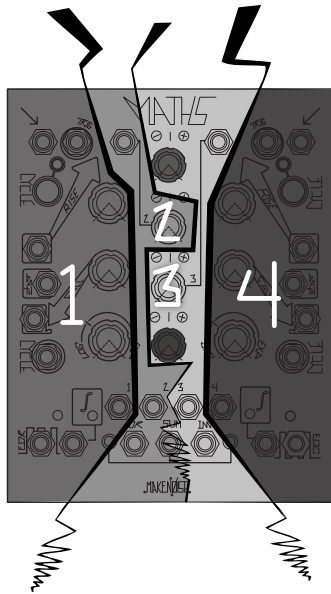

SUM -> DPO VCO B Exp FM
DPO Final -> Monitor

Turn the **DPO's** VCO B frequency knob to 12 o'clock, **FM** and **Mod Bus Index** controls full CCW and **Fold Panel Control** to about 9 o'clock. You should hear a steady tone coming from the **Final** Output. Adjust the VCO B Expo FM Input attenuator to 12 o'clock. You may hear a very slight difference in pitch. Have a look at the LEDs on either side of the **MATHS SUM** bus: red to the left of OR; green to the right of “INV.” They should both be dark; if one of them is lit, try adjusting the Ch. 2 or Ch. 3 Output attenuverter slightly. These LEDs represent the **SUM** Output, which unsurprisingly is the sum of all four signals present at each of the Channels, with levels set by their associated attenuverters, which are arranged vertically. Start Ch.1 cycling and turn up its attenuverter gradually. You should see the green LED start to light in time with the cycle and hear positive frequency modulation coming in.

Try adjusting the Ch. 2 attenuverter up and down from 12 o'clock. What happens here is that the voltage being generated by Ch. 2 is being added to the cycle of Ch.1. In practice, it allows us to move the cycle “up” and “down.” Try adjusting Ch. 1 Counterclockwise as well, listening and watching for the difference this makes.

MATHS is laid out from top to bottom and is roughly symmetrical horizontally, with the outer channels (1 and 4) having more complexity and control than the inner channels (2 and 3). The four white knobs in a vertical row down the middle are output attenuverters for each of the four channels. As shown in the above tutorials, the medium white knobs control the shape and timing of the upward and downward slope generators in Channels 1 and 4.

We've already covered function generation a bit above, so let's look at how MATHS can combine and alter CV. Start by setting all four white knobs to 12:00, Fall settings to 12:00, Rise settings full CCW, and Response knobs to “Linear.”

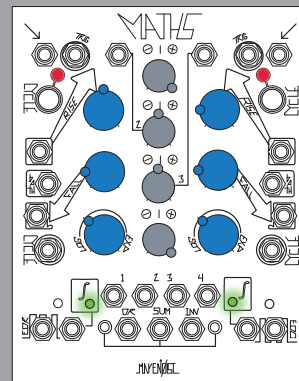
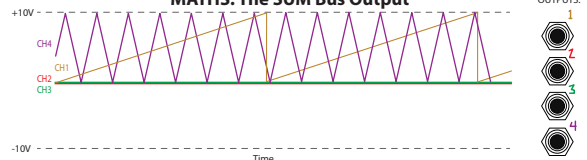
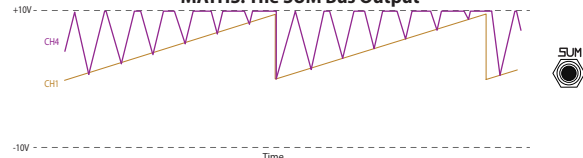

FIGURE 39:
MATHS: The SUM Bus Output



Channel Variable OUTs: Each jack outputs a voltage corresponding to each Channel's attenuverter setting at a given time (illustrated in color for clarity). Notice, Ch. 2 and Ch. 3 are set to 0V (i.e. 12 o'clock).

FIGURE 40:
MATHS: The SUM Bus Output



SUM Bus Output: The resultant waveform is a combination of the signals present at Ch.1 through Ch. 4., according to each Channel's attenuverter settings. Since Ch. 2 and Ch.3 are at currently at 0V, they are not affecting the SUM Output. Therefore, Figure 40 shows only the Ch.1 and Ch.4 Voltages/Signals “added” together.

Notice: the output clips as soon as the Voltages reaches +10V, as the SUM Bus Output can not be greater than +10V or less than -10V.

Have a look at **Figure 41: MATHS Voltage Subtraction**. In this scenario, the CHannel 2 and 3 Offset Voltages are added together at the SUM Output (Channels 1 and 4 are ignored because Cycling is OFF). Because CHannel 3 has value of -5V, it is in effect, subtracted from CHannel 2's +10V Panel Control setting. Setting one attenuverter to a positive value while the other is negative results in voltage "subtraction."

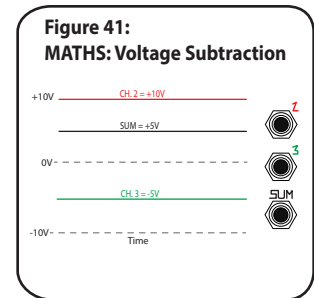
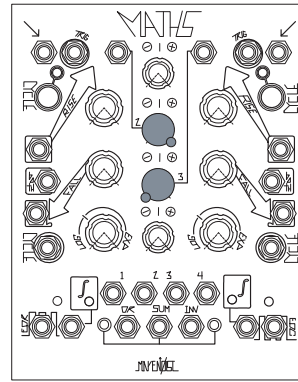

Try plugging a "dummy" cable, a cable with nothing patched at the other end, into the Ch. 4 signal Output labeled "4." Notice that this action removes the Ch. 4 cycle from the SUM. Try plugging the dummy cable into Ch. 4's Unity Output. Notice here that the result is different, as the Ch. 4 cycle is not removed from the SUM. This is an example of the Normalization in the system. All four channels' signal Outputs behave this way: if you patch them elsewhere they are removed from the SUM bus. This allows you to use MATHS as, for example, a three channel mixer with a "floating" independent channel patched elsewhere. The Unity Outputs give you the ability to use Ch.1 and Ch. 4's Outputs individually *without* removing them from the SUM.

OK, return MATHS to its initial settings from the beginning of this tutorial and patch:

OR -> DPO VCO B Exp FM

Try doing some of the same things with the various controls and see if you can figure out how the OR differs from the SUM Output.

You may notice that negative voltages are not output from OR. You may also notice that the voltages are not added together, but rather, all four channels are present in some way, when their attenuverters are set to positive values.

What the OR does is look at the all four channels and at any given moment, it outputs the maximum positive voltage present. So, whichever CHannel has the largest voltage is what comes out of the OR Output at any given time (**Figure 43**).

Set the Ch. 2 attenuverter back to 12 o'clock and engage Cycling on Ch. 4. You should now have two cycles with independent rates and shapes that are summed together. Try changing the Shape, Rate, Amplitude, and Polarity of the two cycles, watching and listening for the effects.

MATHS as a Lag Processor

Another way to use MATHS is as a **Lag Processor** or **Slew Limiter**. By patching a signal to the signal input on Ch. 1 or Ch. 4, any change in the signal can be slowed down. The Rise and Fall controls can be used for independent Slew Rates, depending on whether the voltage is rising or falling. A classic example: when a Logarithmic slew is used to control pitch, it is analogous to the "Glide" or "Portamento" control on many keyboard synthesizers.

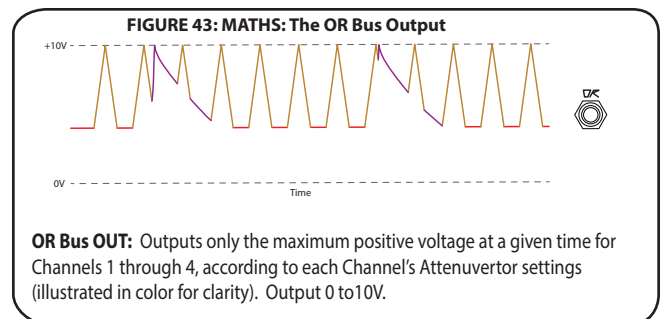
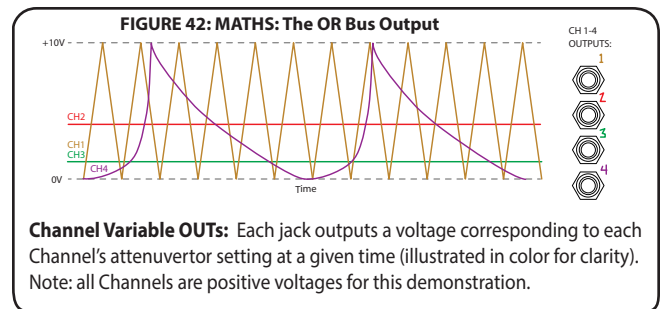

Set MATHS Ch.1 Rise and Fall both full CCW, and Response to Linear. Disengage Cycling. Set Ch.4 Rise and Fall to about 11:00, Response to Linear, and engage Cycling.

MATHS Ch.4 EOC -> René XClk

The EOC (End Of Cycle) outputs a Gate whenever the channel is not in its "Fall" phase. Since the channel is currently cycling, it is useful as a clock. Every time René receives a clock it advances one step on the X-Axis. Each Location on the René's Touch Grid is tuned to a particular output voltage, which is set by the panel control for the given location.

**René QCV -> DPO VCOB 1v/Oct
DPO VCOB Sine -> Monitor**

You should hear a 4-step melody playing at the speed of the MATHS cycle. Adjust the clock rate (via Ch. 4 Rise/Fall controls), key and octave (via the VCO B frequency control), and melody (via the four active René panel controls) to taste. Now that you know what the melody sounds like, let's add slew with MATHS. Make the following adjustment to the patch:

**René QCV -> MATHS Ch1 Signal IN⁹
MATHS Ch1 Unity -> DPO VCOB 1v/Oct**

The patch should look like the one on page 26. It is the same as before, except that the sequential voltage is going through the MATHS Channel before it modulates the pitch. It should sound basically identical to before. However, if you turn up the Rise panel control, you should hear the pitch "gliding" upwards even as it still "steps" downward. Conversely, if you turn up only the Fall panel control, you will hear the pitch "gliding" downwards. If your Clock is steady and either Rise or Fall goes long enough, it may reach the point where it is too long to reach some notes, **Figure 46**. Turn them both up slightly past this point and the original "melody" might be lost entirely.

As you've now seen, MATHS takes advantage of the fact that all the system's signals take the same form (voltage in the +/-10V range) and expands on the simple concepts of movement, attenuation, addition, subtraction, and "speeding up" and "slowing down" in order to achieve a great versatility and any number of uses. As with all the modules in the Shared System, MATHS has its own manual which goes much further in-depth on its many capabilities: www.makenoisemusic.com/content/manuals/MATHSmanual2013.pdf

⁸ If your René's clock is not advancing, or it is advancing through more or fewer than the 4 steps of one row on the X-Axis, try setting it back to defaults as shown in the video: "René Initialization Procedure:" <http://www.youtube.com/watch?v=jQMpTmb1fAU>
⁹ Note, on Ch1 and Ch4, the distinction between Signal and Trigger inputs.

Figure 43:
Wogglebug: Random Stepped Voltage

Figure 44:
MATHS: Processing Random Stepped Voltage

Random Voltage w/ Negative Slew:
Rate is controlled by the MATHS Ch.1 Fall Control. Notice the 'Angle' or 'Curve' of the Slew is constant, with each of the MATHS' Fall cycles completing before a new cycle begins. The original Random Stepped Voltage for clarity.

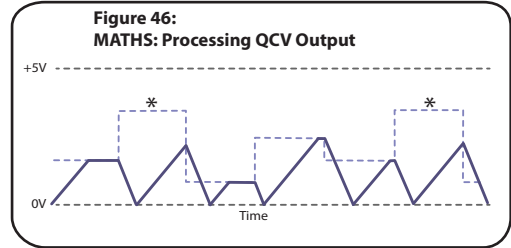
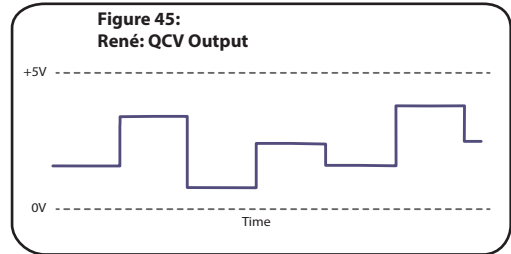
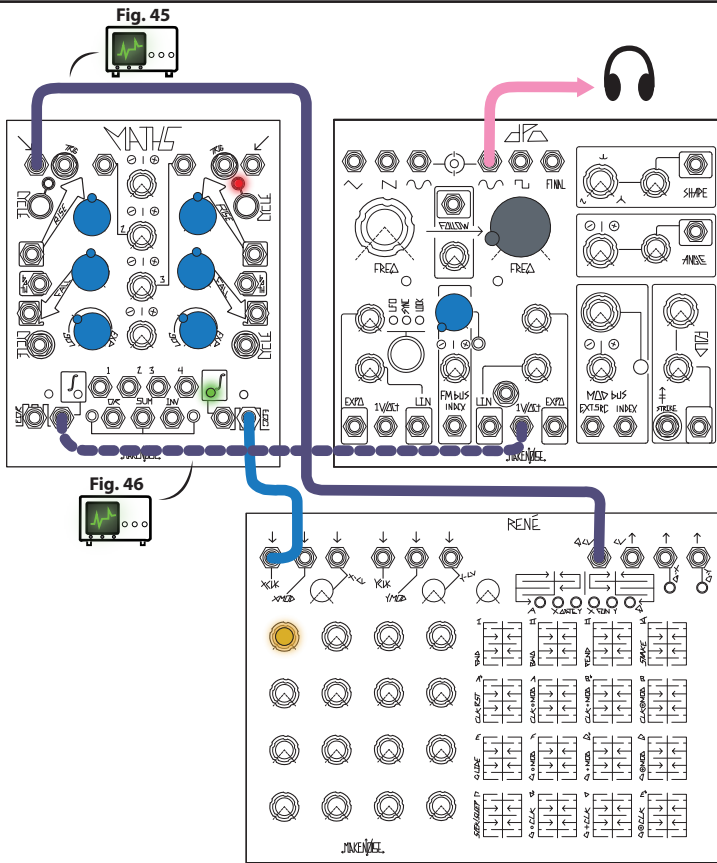

Slew “Not Making It:”

The Rate is controlled by the MATHS Ch.1 Rise and Fall Panel Controls. Again, the “Angle” of the Slew is constant with each of the MATHS Fall Cycles completing before a new Cycle begins. The “*” on the graph represents a Rene step that never makes its way to the DPO, as the previous function takes too long to complete.

The DPO's Expo FM inputs, as shown in the DPO and MATHS Tutorials, are useful for gaining an understanding of the shape different Control Voltages take and what they are doing. Pitch (ie. Frequency) Modulation is easy for the human ear to discern as it's been trained for a lifetime to hear melody. With that in mind, try patching all sorts of outputs to one of the Expo FM inputs and see and hear the results. When you tire of that, try turning knobs all over the DPO and others to see what they do. Find some parameters you like and try using CV for them instead. Below is short list of the basic uses of the modules in the Shared System:

CV and Gate Sources:	
• Functions, LFOs, Gates, Clock, Offsets:	MATHS
• Manual functions, Gates, and manually-selected Sequential Voltages:	Pressure Points
• Manual and Clocked Sequential Voltages, and Clocked-Gates:	René*
• LFO:	DPO (VCO A's LFO mode)
• Random Voltage, Random Gates, Clock:	Wogglebug*
Audio Sources:	
• Dual VCO with selected and variable waveforms:	DPO
• 3 Random VCOs, Noise:	Wogglebug
• Loops and Feedback:	Echophon (Requires signal input or "Frozen" buffer)
• Loops and Granular Synthesis:	Morphogene (Recording required before manipulation)
Signal Manipulation:	
• Mixing, VCA, mild filtering:	Optomix
• Mixing, VCA, Ring Modulation, voltage-controlled Inversion:	modDemix
• Mixing, Addition, Subtraction, Slew:	MATHS
• Sample & Hold variable-Randomization of input:	Wogglebug
Signal Processors:	
• Voltage-Controlled Echo, Looping, and Pitch-Shifting:	Echophon
• Modeless, continuously-variable Reverb algorithm:	Erbe-Verb
• Recording, Looping, Granulation, and Time Lag Accumulation:	Morphogene

Figure 45: Shared System Inputs/Outputs:

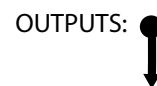
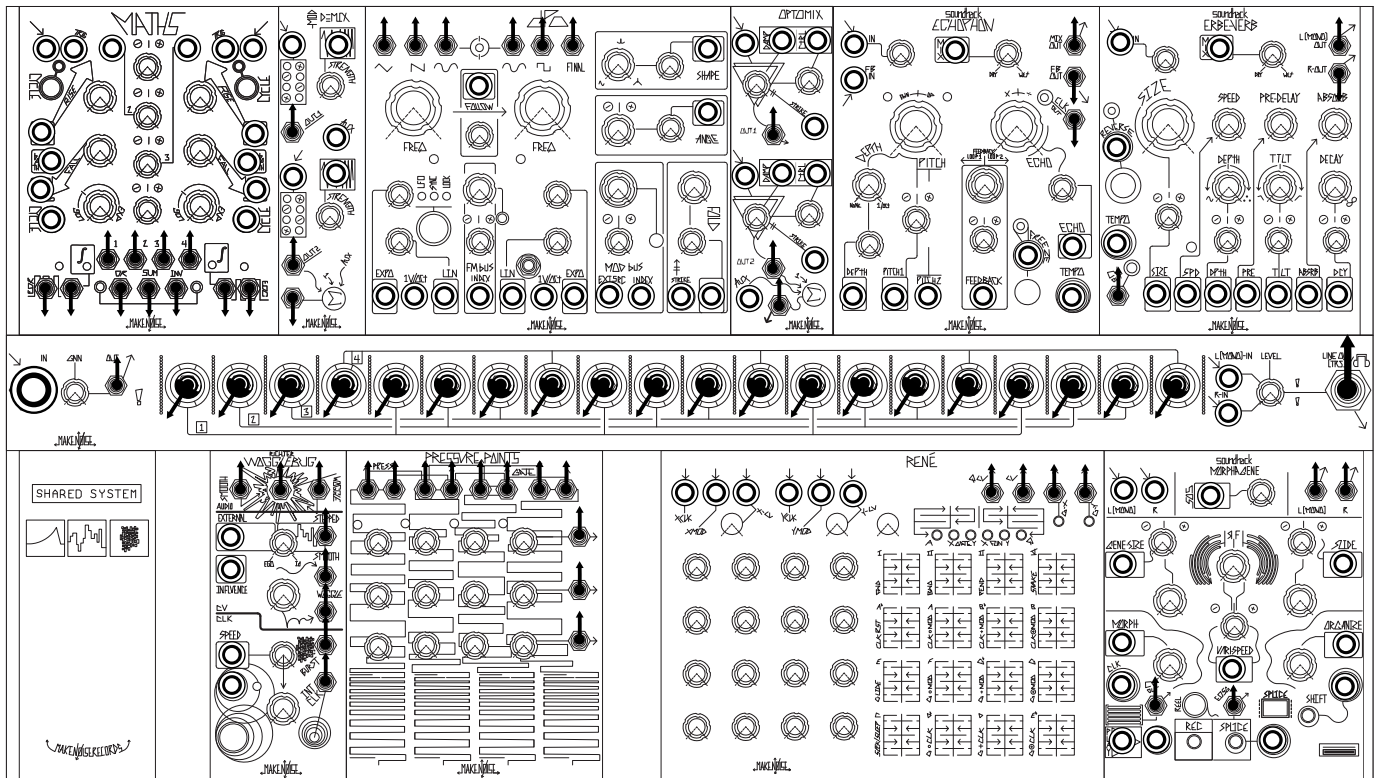

* Requires Clock inputs in X-Clk and/or Y-Clk for clocked use.

* Make sure Ego/Id panel control is turned up and Clock Rate is not Zero.

* In order to use CV Outputs as Noise Sources, turn the Clock Rate and its input Attenuator all the way up.

modDemix: <http://makenoisemusic.com/moddemix.shtml>
<http://makenoisemusic.com/content/manuals/modDemixMANUAL.pdf>
<https://www.youtube.com/playlist?list=PL0jGFC0FWQsiRt1Y21Jz12Wx5r7s0caXb>

- Patch ideas: Ring Modulation, Dual VCA, Amplitude Modulation, Chainable Mixer, Voltage Controlled Polarizer, Octave UP

The modDemix consists of 2 identical direct coupled circuits that may be used together or independently to process audio or control signals by means of amplitude modulation and the many derivatives of AM such as double/ single-sideband, voltage controlled amplification/ attenuation, voltage controlled polarization or multiplication and of course, ring modulation. The modDemix is a specialized amplitude modulation circuit that could be thought of as a "Thru-Zero VCA," meaning that in addition to the AM, when the Carrier signal (called Carrier/ CV) changes phase, the resulting signal's phase will flip as well. The circuit used within the modDemix will, with ease, turn OFF around zero volts at the Carrier/ CV Input, a characteristic that makes the circuit behave very well as a VCA.

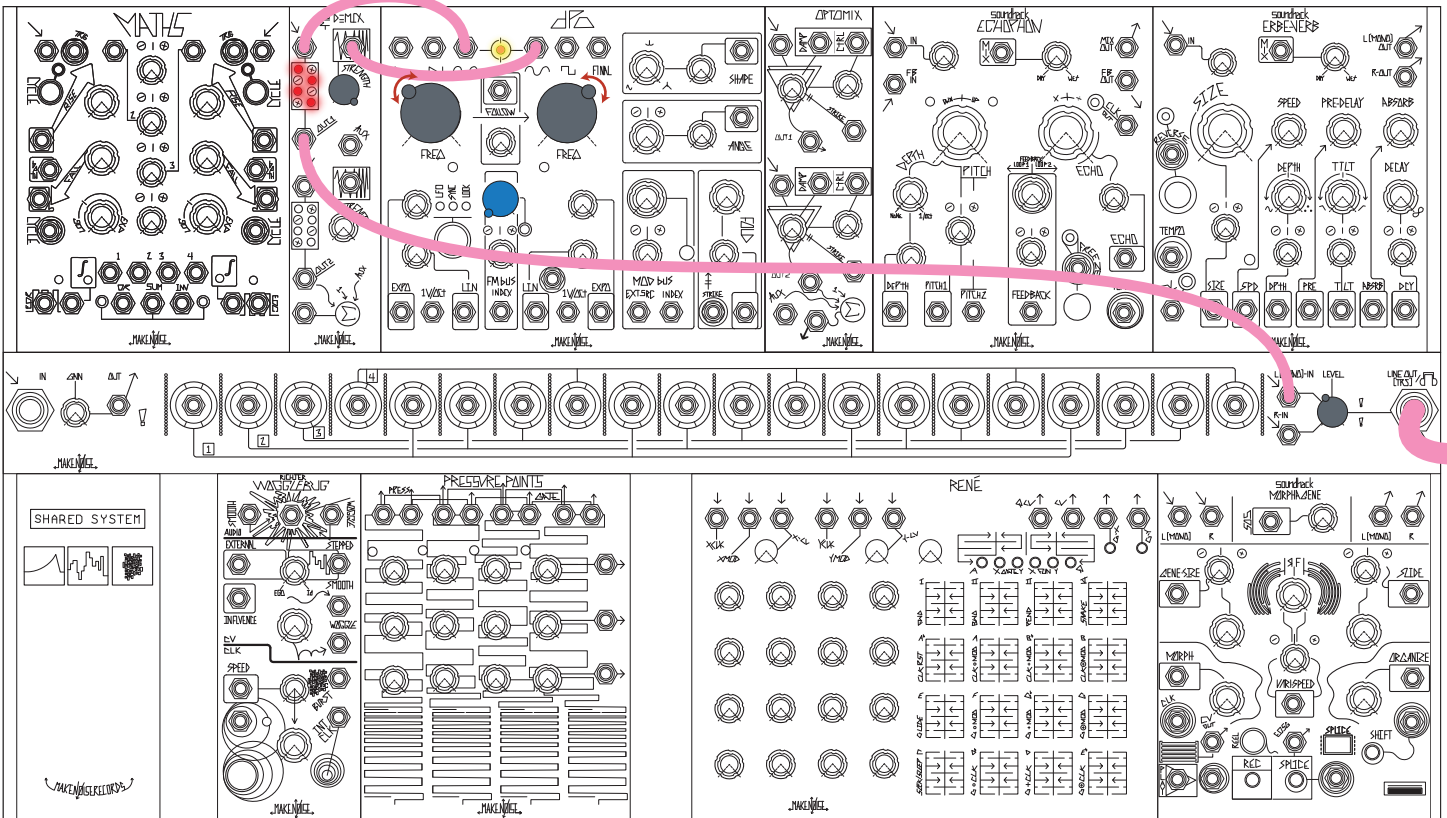

Figure 47: Sample ModDemix Patch

- Two-Channel Mixer with Aux input; each channel is a bipolar VCA.
- Basic use: Patch two audio signals to Signal and Carrier inputs for ring modulation. Monitor Channel or SUM Output.

Optomix: <http://makenoisemusic.com/optomix.shtml>
<http://makenoisemusic.com/content/manuals/optomixrev2manual.pdf>
<https://www.youtube.com/playlist?list=PLEBACF275D3560B36>

- Two-channel mixer with Aux input; each channel is a Low-Pass Gate.

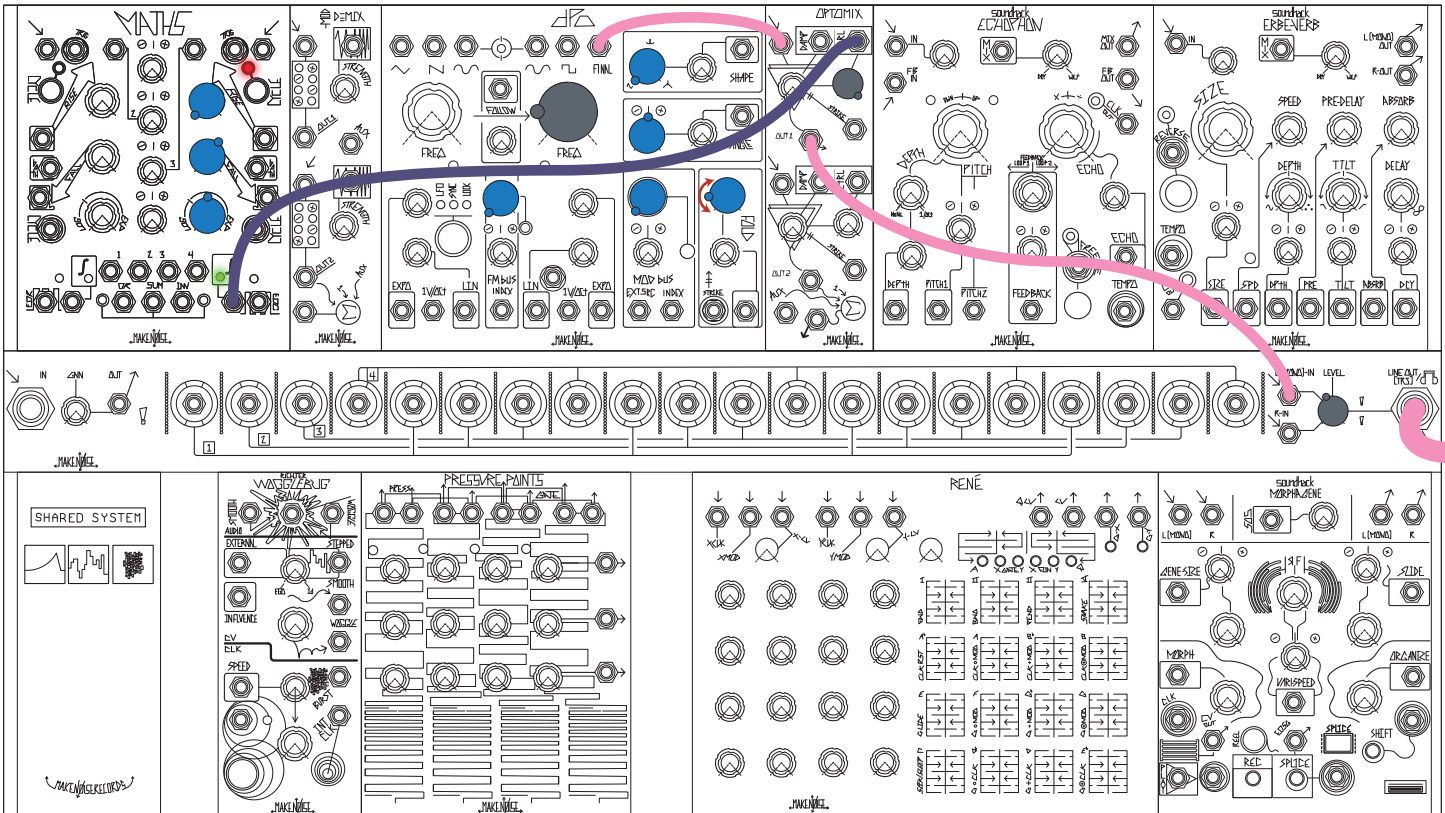

Figure 49: Sample Optomix Patch

Basic use: Patch oscillator Output to a Channel's Signal Input; function from MATHS to associated Control input. Monitor Channel or SUM Output.

soundhack Echophon: <http://makenoisemusic.com/echophon.shtml>
<http://makenoisemusic.com/content/manuals/EchophonManual.pdf>
<https://www.youtube.com/playlist?list=PL281DCBADF031467E>
 • Pitch-shifting; tempo-syncable, digital echo with three feedback paths.

The Echophon is a Pitch-Shifting Echo with smooth time Modulation, Tempo Sync, saturating Feedback, and a unique algorithm, inspired by the Springer Tempophon and lovingly engineered by DSP Guru Tom Erbe of soundhack. Upon release, it was called "the most inspiring module of the year" by Electronic Musician magazine.

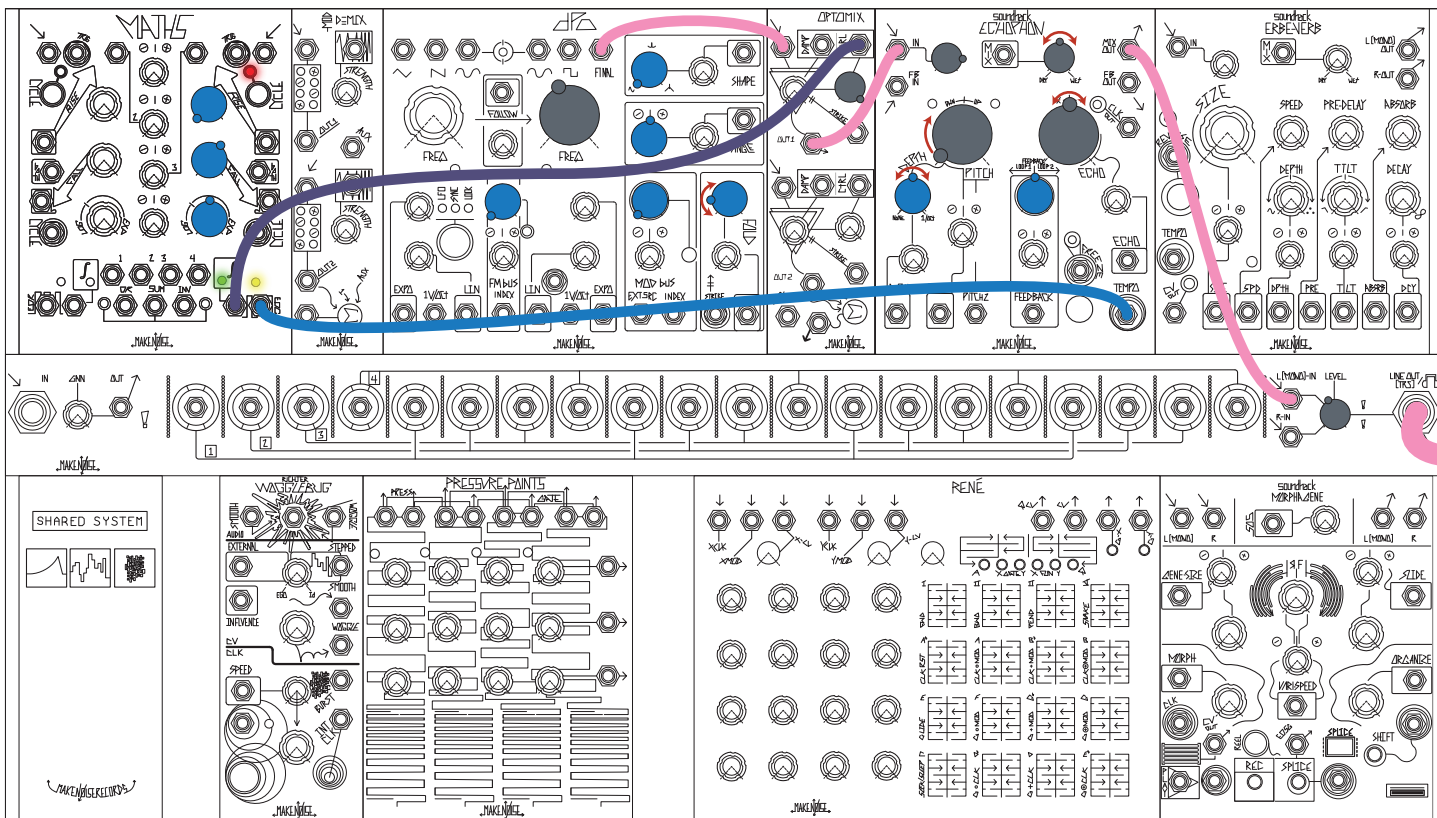

Figure 50: Sample Echophon Patch

Basic use: Patch any audio to input. Use Pitch, Feedback, and Echo to control Delay. Monitor Output.
Patch ideas: Slapback Echo, Pitch Shifter, Feedback Device, Melodic Ghosts, Looping and rePitching

CV Bus: •Utility for Horizontal Disribution of Control Signals, External signal conditioner, Output amplifier for Line Output or Headphones

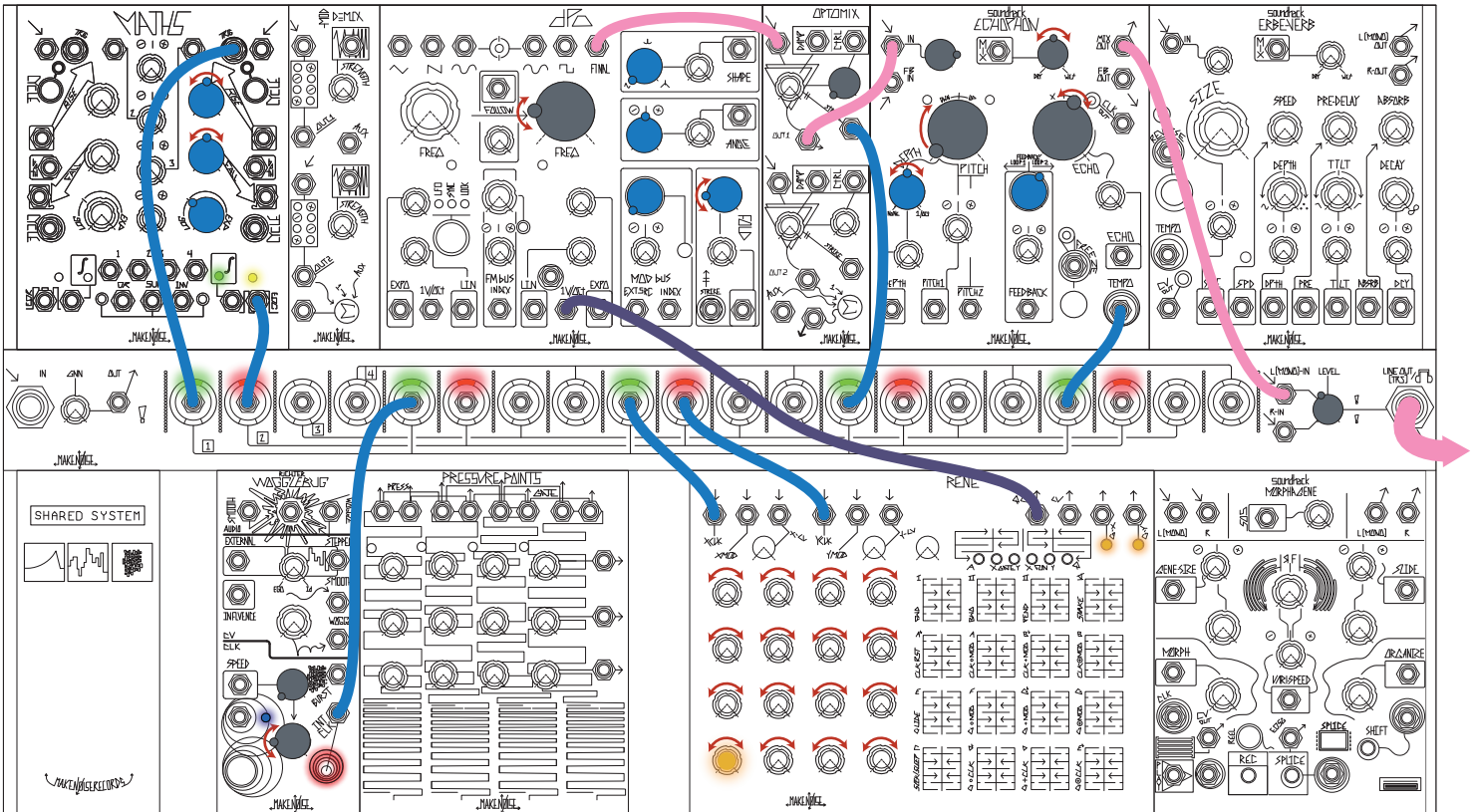

Figure 52: Sample CV Bus Patch

Basic use: Patch a signal to be Multed to any jack. Take the Output from any other jack on the same color-coded Channel.

Wobblebug: <http://makenoisemusic.com/wobblebug.shtml>
<http://makenoisemusic.com/content/manuals/WobbleBugManual.pdf>
<https://www.youtube.com/playlist?list=PLA5153D7609A4FC41>

- Patch idea: Sample and Hold, Chaotic Clock, Pitch to Voltage Conversion, Bit Crush, Patch Exciter

The Wobblebug is a random voltage generator, originally designed by Grant Richter of Wiard Synthesizers. The Wobblebug's purpose is to overtake control voltages during performance and give a voice to the Shared System's ID. It is your synthesizer's ID MONSTER. Amongst other things, the Make Noise Wobblebug contains the following: 1 Voltage-Controlled Clock, 1 Sample & Hold, 2 Lag Processors, 1 Random Gate Burst Generator, and 2 VCO Digital Ring Mod: most of which are patchable via the instrument's panel in a system that is capable of CV and Audio Signal generation and processing.

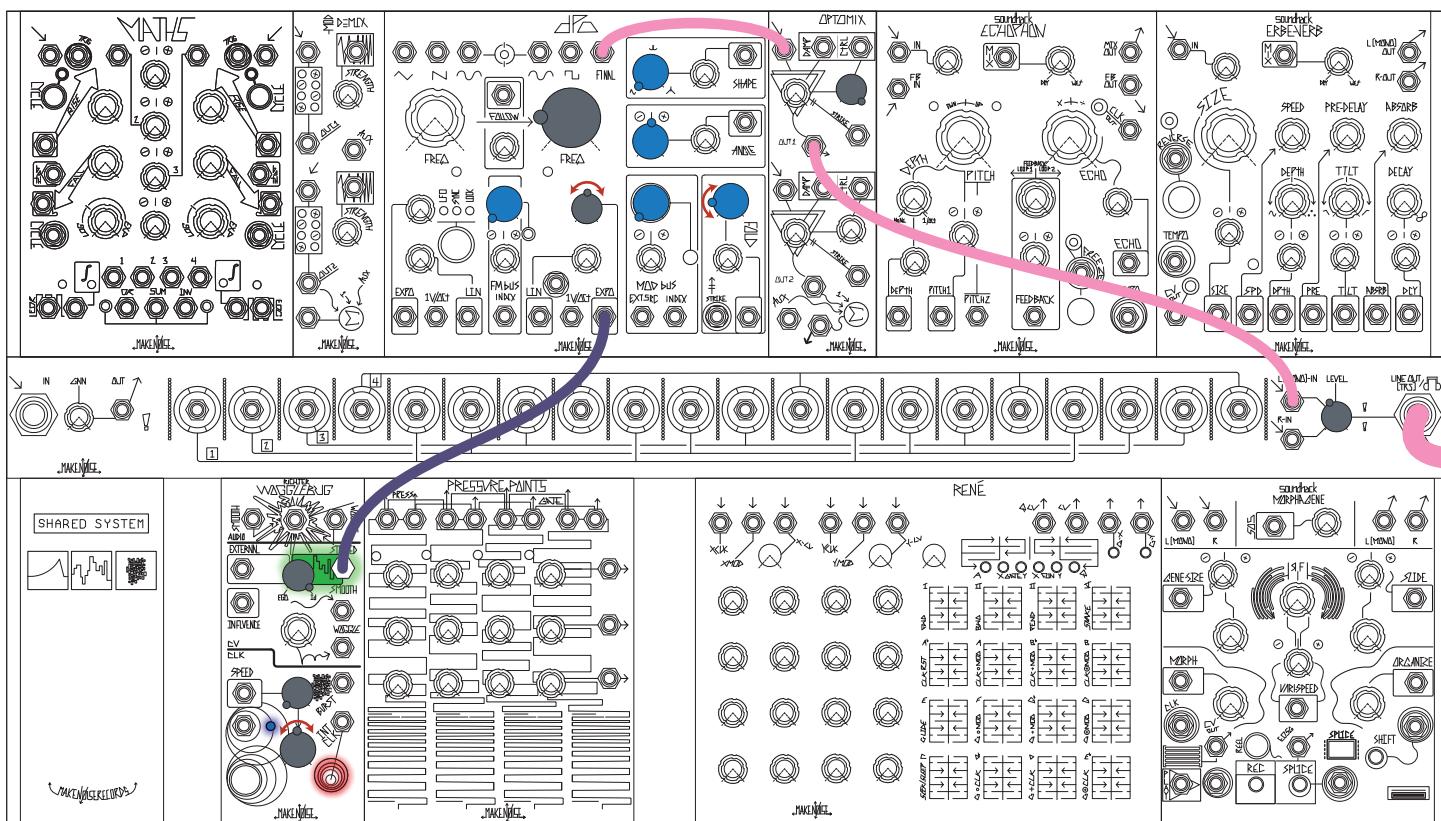

Figure 53: Sample Wobblebug Patch

Basic use: Patch Stepped, Smooth, or Wobble Output to any CV input for Randomization of parameters.

Pressure Points: <http://makenoisemusic.com/pressurepoints.shtml>
<http://makenoisemusic.com/content/manuals/PressurePointsManual.pdf>
<https://www.youtube.com/playlist?list=PLAA5FCFD16984D4E0>

- Patch ideas: Latched/toggling control signals, Preset storage (store four sets of 3 parameter values to be recalled at the touch of a finger), Tactile keyboard with "aftertouch," Manual bongo drum

Pressure Points is a controller in which 1 of 4 sets of 3 tuned voltages are selected by touching the corresponding printed copper wire at the bottom of the instrument. Touching Pressure Points, you become part of the circuit, generating a gate signal (Gate OUT), a control signal proportional to the amount of pressure applied (Press OUT) and activating the corresponding Stage. The Tuned Voltages for the activated Stage appear at their respective X, Y and Z OUTs. In this way, Pressure Points is like an analog sequencer that is played by hand.

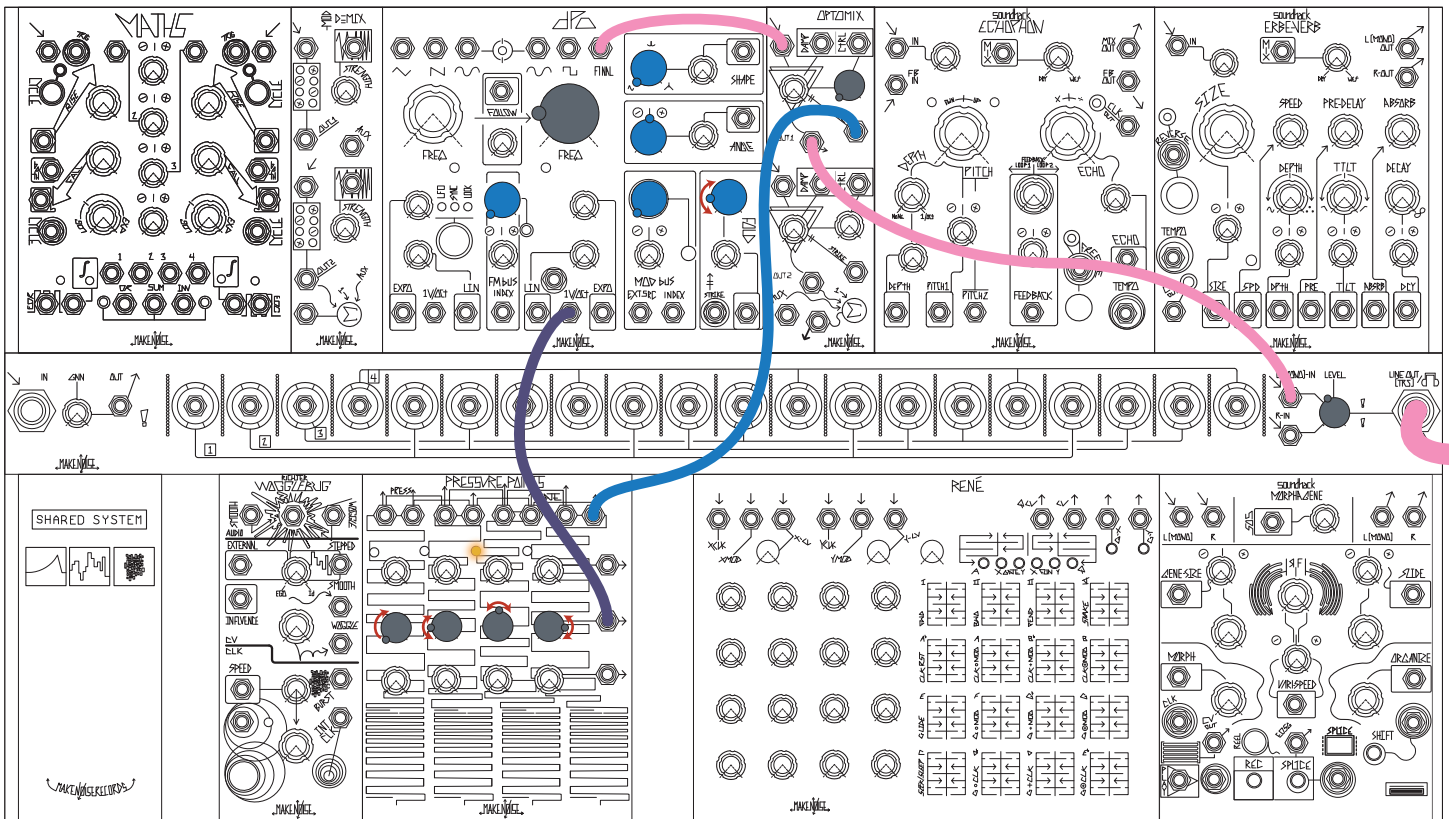

Figure 54: Sample Pressure Points Patch

Basic use: Patch Tuned voltage output to 1v/oct input on DPO, patch common Gate to Optimix Strike, patch DPO waveform to Optimix Signal In. Play "keyboard" with individually tunable keys.

René: <http://makenoisemusic.com/rene.shtml>
<http://makenoisemusic.com/content/manuals/ReneManual.pdf>
<https://www.youtube.com/playlist?list=PL980BA0B8E062C7E0>

- Cartesian CV and Gate sequencer, can be clocked, addressed, and/or played with touchplates.

René is the world's only Cartesian Sequencer for music synthesizers. Named for the French philosopher & mathematician René Descartes, it uses his Cartesian coordinate system to unlock the analog step sequencer from the shackles of linearity.

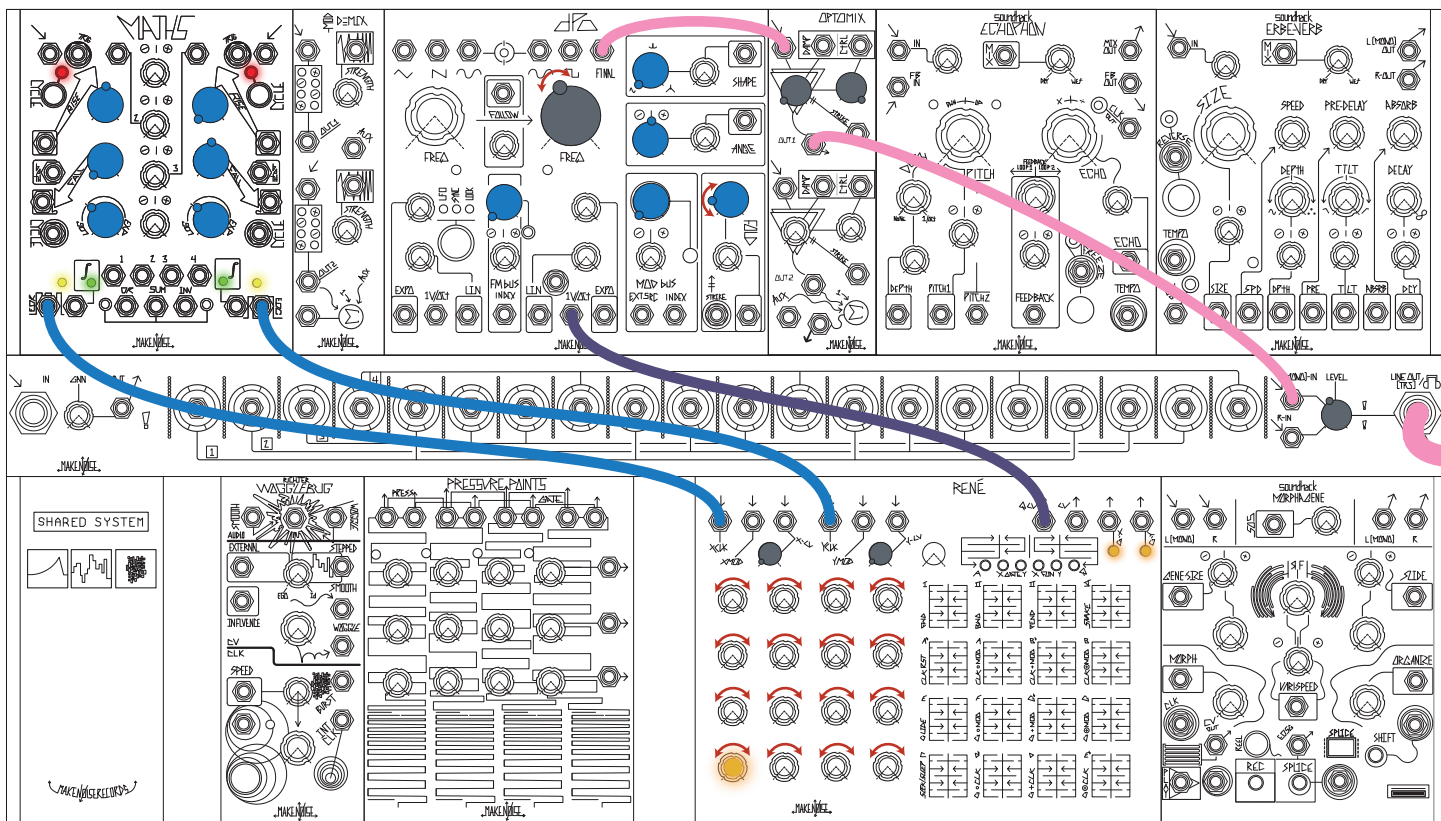
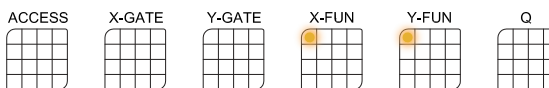

Figure 55: Sample Rene Points Patch

Basic use: Patch clock to X and/or Y CLK inputs, patch QCV to DPO 1V/Oct Input to sequence pitch.



Morphogene: <http://makenoisemusic.com/morphogene.shtml>
<http://makenoisemusic.com/content/manuals/Phonogenemanual.pdf>
<https://www.youtube.com/watch?v=EGkYX0A6Odo&list=PL0jGFC0FWQshZZPzdtUcOJgcrY4h0jsr>

- Digital recording/playback engine for microsound, sample manipulation, and granular synthesis.
- Patch ideas: Granular Synthesis, Sound Collage, Time Stretch/Compress, Regenerative Record, Looping and Chopping, Playable Drum Kit (with Pressure Points), Infinite Overdub

The Soundhack Morphogene is a digital re-visioning and elaboration of the tape recorder as musical instrument. It takes its name from a little known, one of a kind instrument, used by composer Pierre Schaeffer. While it is not an emulation, it does share the primitive, tactile nature of its namesake, and expands upon the original concepts. It is informed by the worlds of Musique Concrète (where speed and direction variation were combined with creative tape splicing to pioneer new sounds) and Microsound (where computers allow for sound to be divided into pieces smaller than 1/10 of a second, and manipulated like sub-atomic particles). Having voltage control over every parameter, it is most dynamic as a digital audio buffer for the modular synthesist.

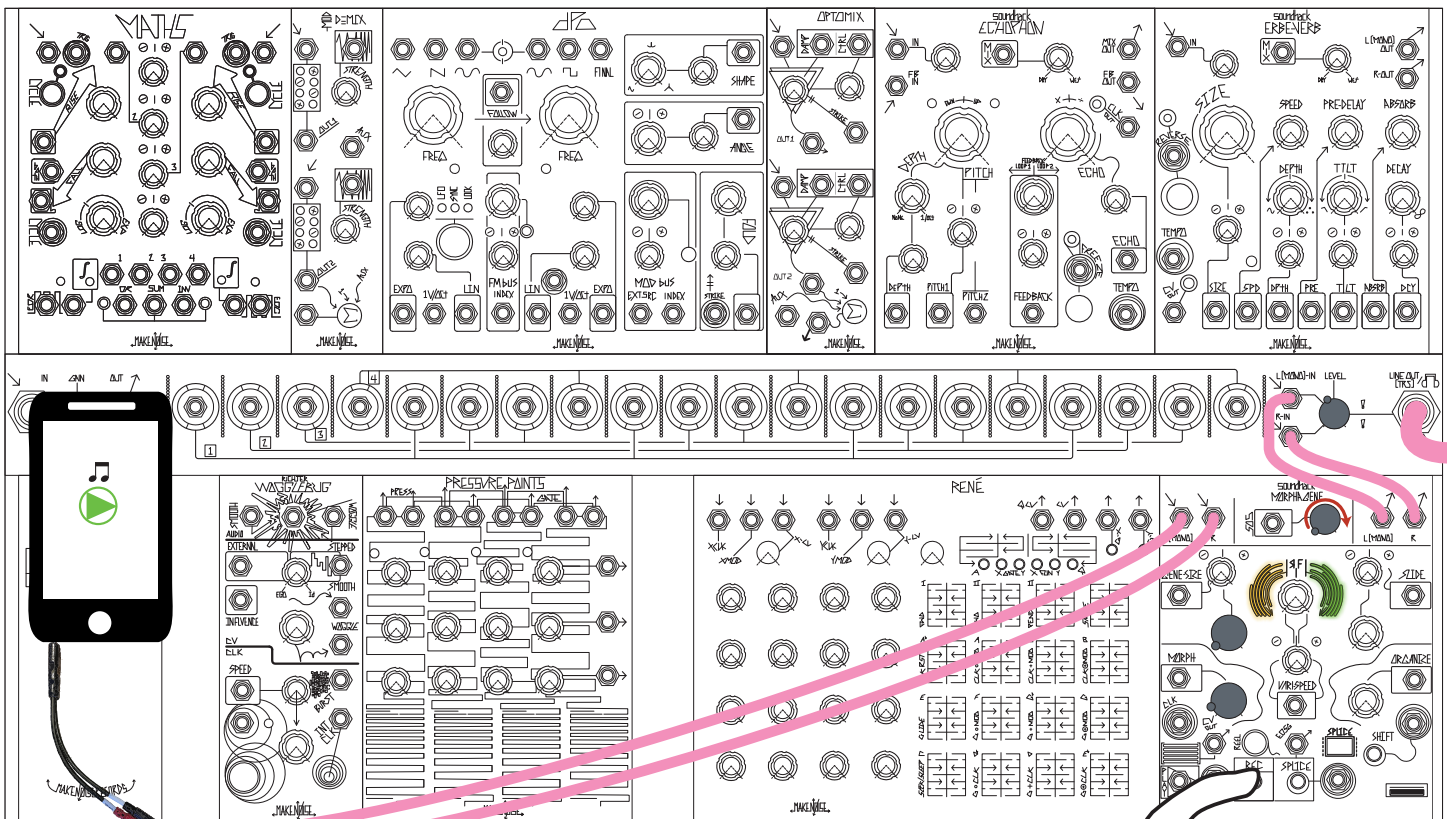

Figure 56: Sample Morphogene Patch

Basic use: patch audio to Input, record with REC button, and change speed and direction with Vari-speed.

Hosa YMM-261 3.5 mm TRS to Dual 3.5 mm TSF Stereo Breakout Cable

Make sure to subscribe to the Make Noise YouTube Channel: <http://www.youtube.com/user/MAKENOISE/videos>

We are constantly adding videos to the library, including module overviews, system overviews, advanced patching techniques, and the ever-expanding System Tutorial: https://www.youtube.com/playlist?list=PL0jGFC0FWQsgWfFdQ85Cd-8P6_UOJKAvp.

Also, once you have delved into the basics of the Shared System you will want to go more in-depth with the individual modules, each of which has a full manual with extensive overview and patch examples: <http://www.makenoisemusic.com/manuals.html>.

-
- Attenuator:** A knob that controls the amplitude of a signal.
- Attenuverter:** A knob that controls the amplitude *and* polarity of a signal.
- Bipolar:** Refers to a signal whose polarity changes from negative to positive and back again.
- Cycling:** When MATHS or FUNCTION is set to self-generate functions.
- Dummy Cable:** A cable with nothing patched at the other end.
- FM (Frequency Modulation):** The use of control voltage to modulate the frequency of an oscillator. When the modulating signal is an audio-rate signal, FM sounds like a modulation of timbre.
- Function:** An event that moves from 0v to another level and then back to 0V over some period of time.
- Gate:** A signal that is either "high" or "low", usually 8v and 0v respectively. Typically patched to a Gate Input.
- Gate Width:** The length (in time) that a Gate stays High.
- Inversion:** Switching the polarity of a signal.
- Lag Processing:** (see Slew Limiting).
- Low-Frequency Oscillator (LFO):** A cycling function whose frequency is too low to be audible except as "clicks;" used for cyclic modulation.
- Low-Pass Gate (LPG):** A circuit that simultaneously changes an audio rate signal's frequency and amplitude content over time.
- Multiple (Mult):** A module that allows patching of one Output to multiple inputs. The abbreviation "mult" can also be used as a verb.
- Normalization:** A jack that is connected to an internal signal until a patch cable is inserted, at which case the normalization is "broken". For example, the individual channel Outputs of **MATHS** are normalised to the SUM, OR and INV circuits. When a patch cable is inserted in a channel Output, it is removed from said circuits.
- Offset:** A constant voltage whose level is set by a Panel Control.
- OR:** A circuit that outputs only the highest voltage present at any of its inputs at a moment in time.
- Panel Control:** A knob that sets the initial value of a parameter by generating an offset. In many cases, incoming CV can be added to or subtracted from this initial offset value.
- Patching:** Making a connection in the System by plugging a cable from an Output to an input.
- Phase:** (see Polarity).
- Polarity:** Whether a signal's voltage level is positive or negative.
- Sequential Voltage:** A series of voltages which are stepped through in a predictable way.
- Slew Limiting:** A slowing of the rate of change of a signal. Also called "Lag Processing" or, when referring to changes in pitch, Portamento.
- Subtraction:** Taking the Sum of two signals, but with one of the signals being inverted.
- SUM:** The result of addition of multiple signals at a moment in time. For example, the sum of +5v and +2v offsets is +7v. Summing can also be called "mixing" especially when referring to the sum of audio signals.
- Unipolar:** Refers to a signal whose polarity does not change (is only positive or only negative).
- Unity:** A circuit or setting that does not attenuate or boost the level of a Signal.
- VCA (Voltage Controlled Amplifier):**
A circuit that uses a signal to control the amplitude of another signal.
- VCO (Voltage Controlled Oscillator):**
A generator of voltage that changes over time (oscillates) in a periodic (repetitive) manner. If the resulting "cycles" are fast enough, the oscillator is a generator of Audio Signals. The frequency of oscillation can be placed under voltage control.
-